

# Wireless World

RADIO AND ELECTRONICS



F457-A (F  
1948  
FEB 4 1951  
IF UNABLE  
PLEASE R.

OCT. 1946

1/6

Vol. LII. No. 10

IN THIS  
ISSUE :

F.M. versus A.M. : COMPARATIVE TESTS

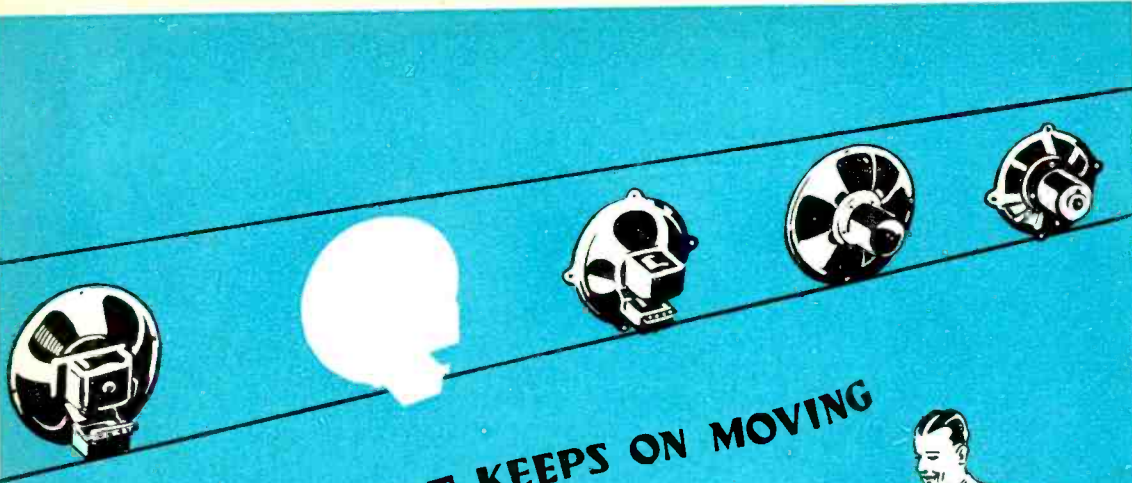

THE LINE THAT KEEPS ON MOVING



**Rola SPEAKERS**  
SELL THEMSELVES ON THEIR REPUTATION

*and the Receivers  
in which they have  
been installed!*

BRITISH ROLA LTD. • GEORGIAN HOUSE • BURY ST. • ST. JAMES'S • LONDON, S.W.1 • ENG.



## Testing Time Ahead . . .

RECONSTRUCTION, as we now know too well, means something other than enjoyment of the non-existent fruits of victory. The amenities of a world at well-earned peace are not for us until we have replaced the ravages of war with the necessities of life and the realities of universal peaceful intent for victors, victims and vanquished alike.

That is speaking collectively . . . For ourselves, we learned much and progressed far in the six years of ceaseless toil, urged on by dire necessity and peril. We are not resting now. We are still pressing on, pressing into the service of those engaged in rebuilding the body and soul of a whole world the knowledge gained, the advancements perfected, the skill and craftsmanship that outmatched the efforts of our enemies.



Head, Trade Mark

### PRECISION ELECTRICAL MEASURING INSTRUMENTS

"Avo" Electrical Testing Instruments set a standard by which other instruments are judged.

- THE UNIVERSAL AVOMETER
- THE "AVO" ALL-WAVE OSCILLATOR
- THE "AVO" VALVE TESTER
- THE "AVO" TEST BRIDGE
- THE UNIVERSAL AVOMINOR
- THE D.O. AVOMINOR
- THE "AVO" LIGHT METER
- THE "AVO" EXPOSURE METER
- Etc., Etc.

Catalogues on application.

Sole Proprietors and Manufacturers:

THE AUTOMATIC COIL WINDER & ELECTRICAL EQUIPMENT CO. LTD., Winder House, Douglass Street, London, S.W.1.

'Phone: VICTORIA 3404-B

# ONCE AGAIN

we show one or two lines taken at random from our stock. We cater for the home experimenter, all items are new and guaranteed.

**CYLDON** precision type single gang .0005 tuning condenser. Heavy construction, ceramic bar insulation. Removable  $\frac{1}{4}$  in. spindle extends back and front. Suitable for either single or ganged operation in instrument or receiver work ..... 12/6

**POTENTIOMETERS** 15-watt type wire-wound, high grade. Diameter 2  $\frac{1}{2}$  in. In two values only, 500,000 and 250 ohms ..... 17/6

**"WEARITE" MIDGET INDUCTORS** shielded in round cans. 1.3/32 in. dia., 1.7/16 in. high plus tags.

- Type  
 207 Mic. or output transformers. Ratio 1/60. 150 m/a on Pri.  
 210 Mic. or output transformers. Ratio 1/15. 75 m/a on Pri.  
 208 Output transformer. Ratio 8/1. 7 m/a on Pri.  
 209 Intervalve transformer. Ratio 1/4.3. 1 m/a on Pri.  
 212 Modulation transformer. Ratio 1/1. 15 m/a both.  
 213 Choke 40H. 4 m/a 4,700 ohms.  
 All types ..... each 15/-

**INDICATOR SCALES** for receiver, amplifier and oscillograph markings. Circular white ivorine scales  $\frac{1}{2}$  in. dia.,  $\frac{1}{8}$  in. centre hole. Calibration and markings in black.

- |               |             |             |
|---------------|-------------|-------------|
| I.F. Gain.    | R.F. Gain.  | Treble.     |
| Amplitude.    | Sync.       | Bass.       |
| Freq. Fine.   | Brilliance. | Volume.     |
| Freq. Coarse. | Mod.        | Gain.       |
| Focus.        | Audio Gain. | Tone.       |
| Attenuator.   | Ver. Gain.  | Hor. Gain.  |
| Trigger.      | Hor. Shift. | Ver. Shift. |
|               |             | "Unmarked." |

- Indicator Scales ..... each 6d.  
 Black Pointer Knob to match ..... each 6d.

**SANGAMO WESTON "S20"** 2  $\frac{1}{2}$  in. flush mounting 0/1 millimeters. Resistance marked 100 ohms ..... £2 11 0

(Good stocks, but new deliveries will show price increase. Buy now !)

Write, 'phone or call—

# WEBB'S *Radio*

14, Soho Street, Oxford Street,  
 London, W.1

Telephone - - - GERrard 2089

Please note our SHOP HOURS—9 a.m. to 5.30 p.m.  
 (Saturdays 9 a.m. to 1 p.m.)

**S.S.W.** TORSIONAL REMOTE CONTROL  
 and FLEXIBLE SHAFT ASSEMBLIES

DEFLECTIONLESS SLOW-SPEED OPERATION ... car radio  
 POWER SHAFTS FOR HIGH-SPEED OPERATION ... speedometers ... tachometers  
 PUSH-PULL OPERATION ... chokes ... starters  
 TENSION OPERATION ... brakes

THE S. S. WHITE COMPANY BRITANNIA WORKS  
 ST. PANCRAS WAY · CAMDEN TOWN · LONDON N.W.1  
 Cable Address: · WHICODENTA, WESDO, PHONE, LONDON  
 Telephone: EUSTON 4758-4759

# NOW AVAILABLE ON REQUEST

**BI Callender's** PAPER DIELECTRIC CAPACITORS

IN TINNED STEEL BOXES

**#18 TYPE**

The primary use of these capacitors is in smoothing and coupling circuits in radio receivers under tropical conditions in which electrolytic capacitors are not suitable. In addition, they are found useful in coupling circuits and telephone work.

The CAPACITOR ELEMENTS are impregnated in a compound chosen for its insulation and dielectric strength.

The BOXES are robustly constructed of tinned steel in standard form; Pattern 1 has plain seams and Patterns 2 and 3 are rolled seams. The latter patterns can be supplied with plain seams if required (dimension B and C are then 1/2 in. less, but the centres remain unaltered).

The CONNECTIONS used in the standard design are 4 BA screws carried in moulded insulators. An alternative design having soldering tabs is also available.

MOUNTING BRACKETS are designed to support capacitors without heavy vibration and, as supplied, are arranged for inverted chassis fitting. Mountings suitable for inverted chassis fitting can be provided if required.

**NOTE**—Unless otherwise ordered, the standard design will be supplied.

**DATA:**  
Working temperature range: -40° C. to 71° C.  
Capacitance tolerance: ±20%

Capacitance (uF)	1,000	2,000	3,000	4,000	5,000	6,000	7,000	8,000	9,000	10,000
0.10	1,000	2,000	3,000	4,000	5,000	6,000	7,000	8,000	9,000	10,000
0.25	400	800	1,200	1,600	2,000	2,400	2,800	3,200	3,600	4,000
0.50	200	400	600	800	1,000	1,200	1,400	1,600	1,800	2,000
1.00	100	200	300	400	500	600	700	800	900	1,000
2.00	50	100	150	200	250	300	350	400	450	500
4.00	25	50	75	100	125	150	175	200	225	250
6.00	17	33	50	67	83	100	117	133	150	167
8.00	13	25	37	50	62	75	87	100	112	125
10.00	10	20	30	40	50	60	70	80	90	100

**BRITISH INSULATED CALLENDER'S CABLES LIMITED**

4 uF  
250V. D.C. WORKING

This catalogue of paper dielectric and electrolytic capacitors for radio work contains essential technical data on a wide range of types. Radio engineers and designers should write for "Radio Capacitors," Publication No. 201T.

**BRITISH INSULATED CALLENDER'S CABLES LIMITED**  
NORFOLK HOUSE, NORFOLK STREET, LONDON W.C.2

# TAYLOR *for the Best in Test Equipment*

MODEL  
**65B**



## ALL WAVE SIGNAL GENERATOR

1. Six wavebands cover from 100 kc/s to 46 mc/s.
2. Scale directly calibrated in frequency.
3. R.F. output controlled by coarse and fine attenuators.
4. 400 c/s internal oscillator provides 30 per cent modulation if required.
5. Unmodulated or externally modulated R.F. output available.
6. Up to 1 volt output of 400 c/s available for Audio tests.
7. Main filters are fitted reducing direct radiation to a minimum.
8. Operates from 110 or 200-250 volts A.C. mains, 40-100 cycles.
9. Dimensions: 12½ in. x 8½ in. x 6 in. deep. Weight about 10 lbs.

Taylor Model 65B is a reliable and accurate mains-operated portable Signal Generator. It is designed for all general Radio frequency and Audio frequency tests on Radio receivers or amplifiers.

Price **£15.10.0**

Please write for technical brochure.

Send enquiries to your usual factor or direct to:

# Taylor

## Electrical Instruments Ltd.

419-424 MONTROSE AVENUE, SLOUGH, BUCKINGHAMSHIRE  
Tel: Slough 21381 (4lines) Grams: "Taylins" Slough

# — Wharfedale —

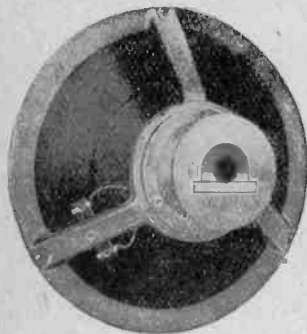

Speech Coil 3 or 15 ohms.  
Impedance. PRICE 75/-

NEW  
**GOLDEN**  
10 inch  
**LOUDSPEAKER**

During the last six years hundreds of Wharfedale Golden Units have been supplied, and are still being supplied, to the B.B.C. and G.P.O. It was selected by reason of

its level response. The new model is fitted with precision die-cast chassis, improved spider, and Alcomax II Magnet increasing the flux density from 10,000 to 12,500. The price is only increased by 5/-.

Made and Guaranteed by  
**WHARFEDALE WIRELESS WORKS**

NEW ADDRESS

**BRADFORD ROAD, IDLE, BRADFORD.**

'Phone: Idle 461.

'Grams: "Wharfedale, Idle, Bradford."

 A black and white photograph of a tall, slender radio mast. The mast is supported by a tripod base and is set against a background of a mountain range under a clear sky. The mast has a small antenna at the top.
 

**★ Aداسترا ★**  
GALVANISED SECTIONAL STEEL  
**RADIO MASTS**  
Send for Catalogue *WQ/230*  
**POLES LTD** TYBURN RD. ERDINGTON  
BIRMINGHAM '24

# NITROGOL *Capacitors*

## THE STANDARD OF TECHNICAL EXCELLENCE, QUALITY AND RELIABILITY

The most modern development in Paper Dielectric Capacitors. Subjected to a new and highly specialised process, with extended foil construction and a mineral base impregnant, they have low power factor, low inductance, uniformity of dielectric and small temperature gradient.

They withstand diversity of temperature, humidity and vibration, making them suitable for use in the most arduous conditions

Manufactured in rectangular metal containers for all normal purposes and in shallow containers for under-chassis mounting, they are fitted with ceramic terminals.

Special cylindrical and rectangular designs are available for Television and other small-ripple high-tension applications.

**MAKERS OF THE WORLD'S FINEST CAPACITORS**

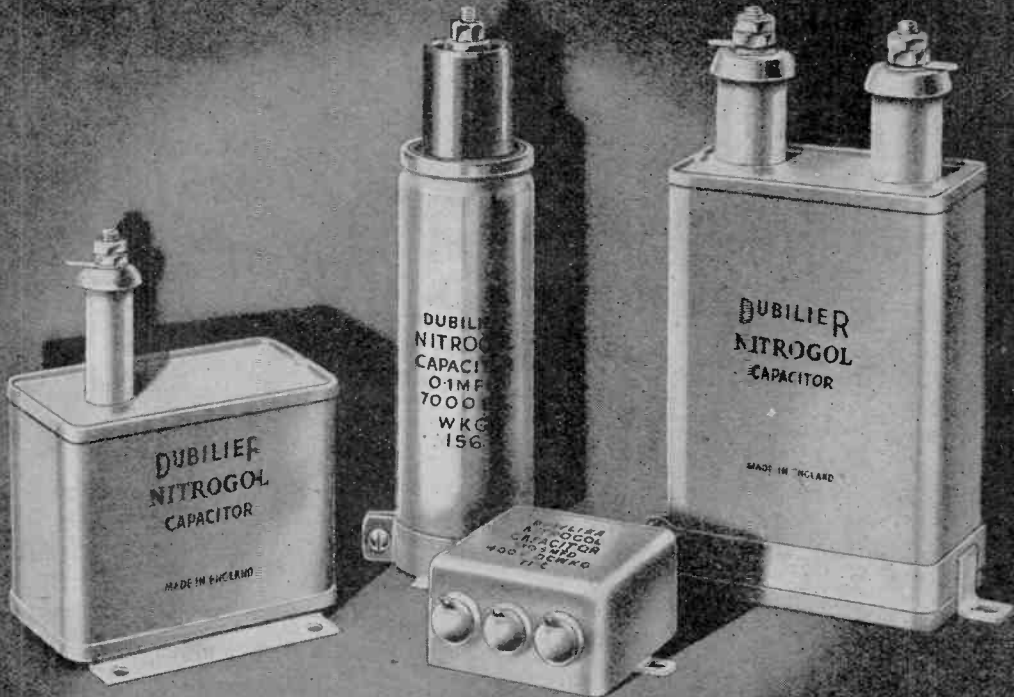

D.6

# DUBILIER

CONDENSER CO. (1925) LTD.

DUBILIER CONDENSER CO. (1925) LTD., DUCON WORKS, VICTORIA ROAD, NORTH ACTON, W.3

Phone : Acorn 2241.

\*Grams : Hivoltcon, Phone, London.

Cables : Hivoltcon, London.

Marconi International Code.

# U.I.C Metallised Ceramics

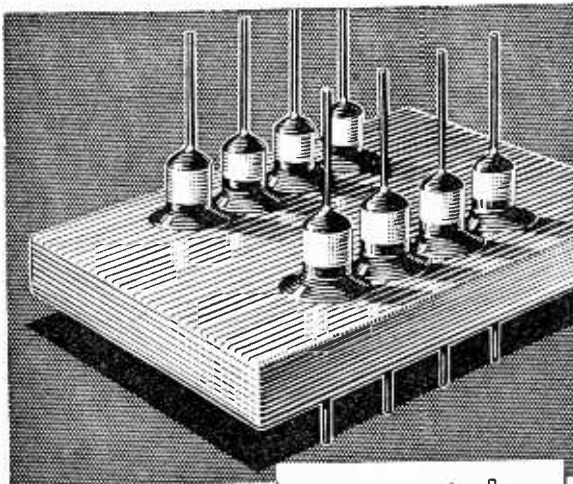

We specialise in the production of all types of Metallised Ceramic components — Hermetic Seals, Sealed Lids, Tag Boards, Bushes, Formers, etc. These are available in soldered, coppered or silvered finish, according to requirements. The suitability of any finish is a matter which we shall be pleased to discuss.

**HERMETIC SEAL  
TYPE HS 421**

Flashover Voltage over outside path. 4.5 KVDC at 20° C.  
Flashover Voltage over inside path 3.5 KVDC at 20° C.  
Small size. Close assembly. Physically robust.

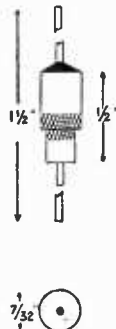

Components made to standard design or to customers' specific requirements. Write for details.

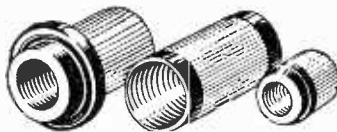

**UNITED INSULATOR CO. LTD**  
Oakcroft Rd., Tolworth, Surbiton, Surrey  
Telephone: Elmbridge 5241 Telegrams: Calanel, Surbiton

*Unsurpassed In Ceramics*

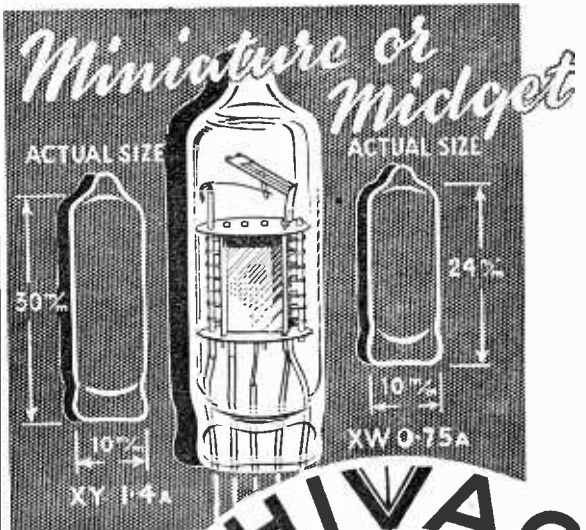

**NEW TYPES FOR**  
MIDGET RECEIVERS  
HEARING AIDS  
METEOROLOGICAL  
INSTRUMENTS  
ETC.



**HIVAC LIMITED** Greenhill Crescent. Phone HARROW  
Harrow on the Hill, Middx. 0895



## FOR THE RADIO SERVICEMAN DEALER AND OWNER

The man who enrolls for an I.C.S. Radio Course learns radio thoroughly, completely, practically. When he earns his Diploma, he will KNOW radio. We are not content merely to teach the principles of radio, we want to show our students how to apply that training in practical, every-day radio service work. We train them to be successful!

Write to the I.C.S. Advisory Dept. stating your requirements. Our advice is free and places you under no obligation.

.....You may use this Coupon.....  
**INTERNATIONAL CORRESPONDENCE SCHOOLS Ltd.**  
DEPT. 38, INTERNATIONAL BUILDINGS, KINGSWAY, LONDON, W.C.2  
Please explain fully about your instruction in the subject marked X  
Complete Radio Engineering      Radio Service Engineering  
Elementary Radio

And the following Radio Examinations:—  
British Institution of Radio Engineers.  
P.M.G. Certificates for Wireless Operators.  
City and Guilds Telecommunications.  
Wireless Operator and Wireless Mechanic, R.A.F.

Name..... Age.....

Address.....



# POINTERS FOR DESIGNERS

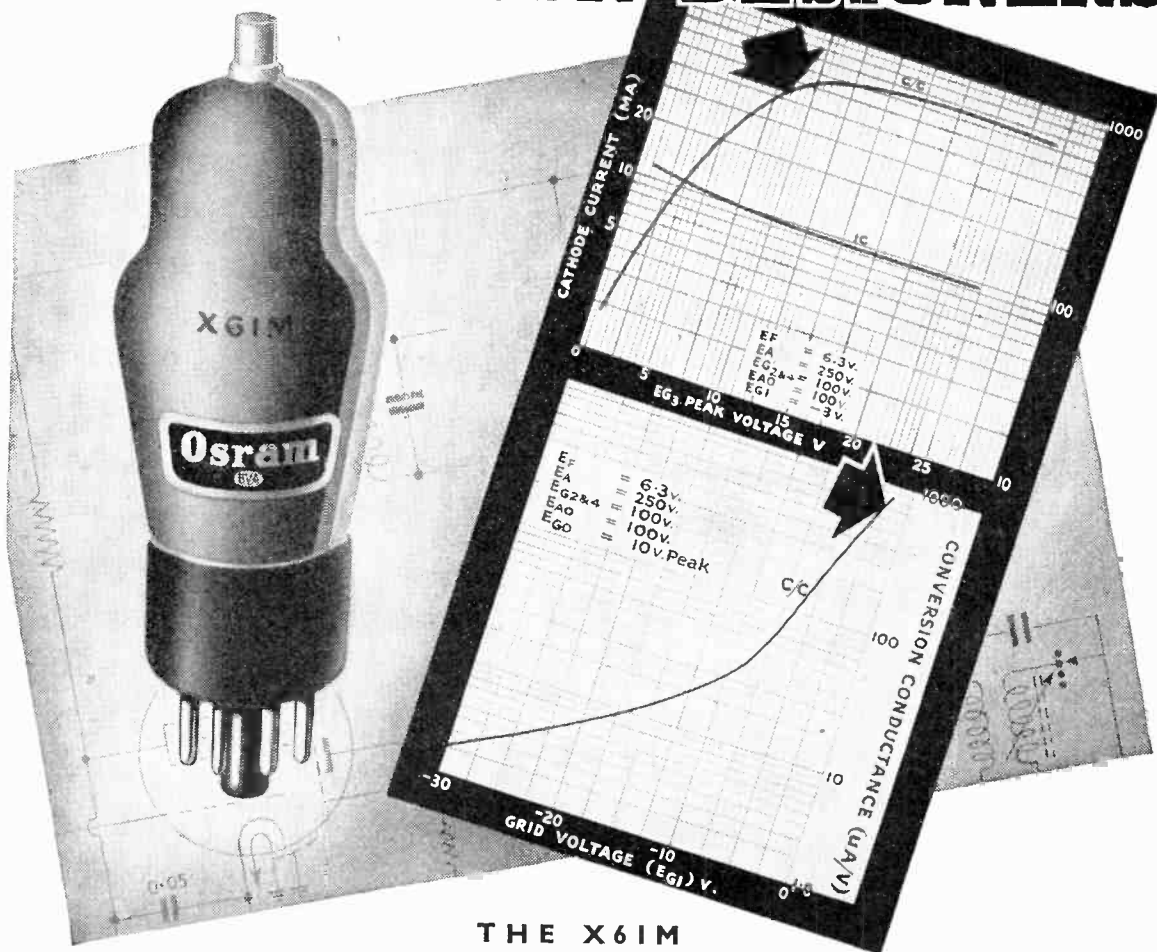

THE X61M

An indirectly heated 6.3v. frequency changer of the Triode-Hexode type, the OSRAM X61M is suitable for operation up to 60 megacycles per sec. (5 metres). Outstanding features include:—

- High conversion conductance for comparatively low cathode current, improving signal to noise ratio.
- Signal handling capacity is such that negligible distortion is apparent up to 5 volts R.M.S. on the signal grid.
- Negligible "pulling" when tuned anode oscillator is used, making ganging of tuned circuits easy.
- Control characteristic is designed to work in combination with KTW61 as IF amplifier, giving maximum control on both valves with negligible distortion.

A detailed technical data sheet is available on request.

**Osram**  
PHOTO CELLS

**G.E.C.**  
CATHODE RAY TUBES

**Osram**  
VALVES

Advt. of The General Electric Co. Ltd., Magnet House, Kingsway, London, W.C.2

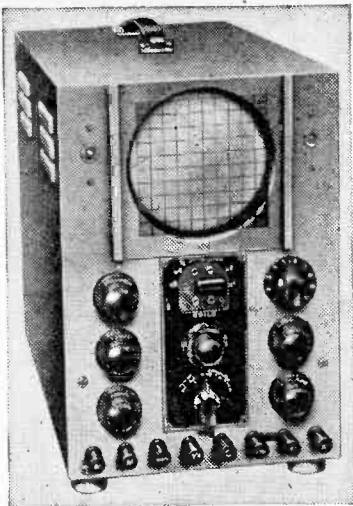

**STATIC TWO-DIMENSIONAL**  
visual delineation of any recurrent law.

**RELATIVE TIMING OF EVENTS**  
and other comparative measurements with extreme accuracy.

**PHOTOGRAPHIC RECORDING**  
of transient phenomena.

**SIMULTANEOUS INDICATION**  
of two variables on a common time axis.

INDUSTRIAL INDICATING and TESTING afford increasing scope for the Cathode Ray Tube as the only device with the above inherent features of which the last is unique in the Cossor DOUBLE BEAM Tube.

The Model 339 Cossor Oscillograph thus equipped is invaluable on all problems of research, production or operational testing, when the effect examined is applied as a voltage. When recurrent the traces are studied visually and when transient are recorded photographically, using Model 427 camera.

**A. C. COSSOR LTD.,**  
INSTRUMENT DEPT.

Cossor House, London, N.5

\*Phone: CANbury 1234 (33 lines).  
\*Grams: Amplifiers Phone London.

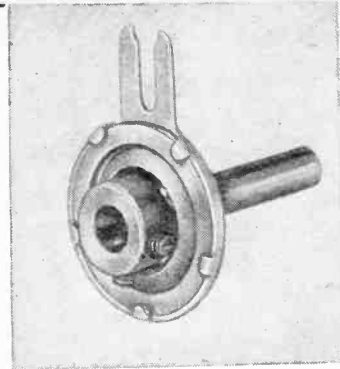
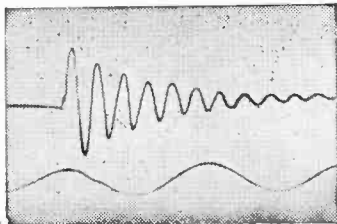

**BALL  
DRIVE**

- SMOOTH, RELIABLE & VERY POWERFUL
- Epicyclic friction drive, ratio 6 : 1
- May be used to increase ratios on other drives or attached direct to component spindle (1/4" shaft).

PRICE 3/3 RETAIL



**JACKSON**  
**BROS (LONDON) LIMITED**  
KINGSWAY · WADDON · SURREY  
TELEPHONE: CROYDON 2754-5  
TELEGRAMS: WALFILCO  
PHONE, LONDON

**M.R. SUPPLIES Ltd.**

offer the following brand new and reliable Radio and Electrical Material. Prompt despatch. All prices net.

**SIGNAL GENERATORS.** We confidently recommend the new BPL Instrument and have already supplied many of the large firms' laboratories. Operation 200/250 v. A.C. Frequencies:—100/250, 250/650, 650/1,600 Kc/s. 1.6/4.5, 4.5/12, 12/30 Mc/s. Accuracy 1 per cent. 1 volt in 10 ohms. All ranges modulated to depth of 30 per cent. by internal 400 c. oscillator (off switch provided). 6in. illuminated scale. 400 c. brought out separately. Double screening, £21 nett (desp. 2/6). Ex stock.

**MEGGERs.** The "Wee-Megger" by Evershed again in stock. Pressure 500 volts. Range 0/20 megohms and inf. Supplied with pocket and log books. 29/10s.

**ROTHERMEL PIEZO-CRYSTAL PICK-UPS,** new low prices.—Senior, in black bakelite, 57/6. Also S.8, with channel steel arm, 54/-. ROTHERMEL Sapphire Gramophone Needles, permanent, fine reproduction, 12/6. STROBOSCOPES (card-board) showing 78, 79 and 80 r.p.m. on 50 c. viewing, 1/-.

**METAL RECTIFIERS** by STC (Selenium). All for charging up to 12 volts at 1.5 amp. 12/6 : 3 amp., 22/6 : 6 amp., 49/6 : 10 amp., 49/6. These are all full-wave, bridge connected. Suitable TRANSFORMERS, all with tapped primary, 200/250 v. Sec.—7, 11 and 15 v. at 2 amps., 20/-. Sec.—8 and 14 v. at 3 amps., 32/6. Sec.—5, 12 and 17 v. at 6 amps., 49/6 (desp. 2/-). These can be sold separately.

**MILLIAMMETERS** by Taylor. High-grade moving coil, 2 1/2in. flush mtg. Deflection 0/500 milliamps (can be despatched for lower reading), 29/6.

**VARIABLE RESISTANCES.** Cressall wire-wound P'meters (or rheostats), 10 ohm, 1 amp., with knob, 5/6. SLIDING RESISTANCES, fully enclosed, 100 watt range—1 amp., 5 ohms, 10 ohms 3 amps, 50 ohms, 1.3 amps., 100 ohms 1 amp., 200 ohms 0.7 amp., or 400 ohms 0.5 amp., any one, 27/6. Also 6 ohms 10 amps (600 watt.) 59/6 (desp. 3/-).

**INSTRUMENT KNOBS.** 1 1/2in. with 2in. skirt, brass bushed with 1/2in. bore, with 2 set screws, 1/3 each, 11/9 dozen.

**POINTER KNOBS,** brass-bushed, 1in., 8d. each, 6/6 doz.

**LOUDSPEAKERS.** We only offer the superior types. Vitavox High-fidelity P.M. models, with high-flux iron magnets, 12in. die-cast chassis, 15 ohms coils, the K12/10 (10 watt), 27. K12/20 (20 watt), £11 (desp. either 5/-). The new Gramplan 7 watt, 9in. P.M. Speaker with either 2 or 15 ohms coil, 38/- (desp. 1/6). The ideal unit for horn-loading. PROJECTOR SPEAKERS, large range in stock for immediate delivery.—Vitavox 10 watt P.M. Unit (15 ohms) with 4 1/2in. all-metal round Horn, £10 10s. (desp. 7/6). With 30in. all-metal square Horn, £8 17s. 6d. (desp. 5/-). Units only.—Vitavox 10 watt, 28. G.E.C. 12 watt (with line trans.), 27/10s. Reslo and Gramplan 10 watt, 27/5s.

**HAND MICROPHONES,** ex-Govt., new. Superior carbon type with press-switch, 5ft. lead and plug, 9/6.

**FOR CALLERS ONLY**

Large range of G.E.C., Gramplan and Vortexion POWER AMPLIFIERS, A.C. and Mobile (12 v.), with or without radio stage, 15 watts to 50 watts, prices £12 to £37 10s. WAVEMETERS, ex-Govt. Class D Mk II, new, great bargain, 25 17s. 6d. Usual range of ROTARY TRANSFORMERS.

Please include sufficient for despatch where not stated

**M.R. SUPPLIES Ltd., 68, New Oxford Street, London, W.C.1**

Telephone: MUSEum 2958

*The better  
they are made  
the more outstanding  
the results*

# Bullers

*Specialize in PRECISION Manufacture*

## MADE IN THREE PRINCIPAL MATERIALS

### FREQUELEX

An insulating material of Low Di-electric Loss, for Coil Formers, Aerial Insulators, Valve Holders, etc.

### PERMALEX

A High Permittivity Material. For the construction of Condensers of the smallest possible dimensions.

### TEMPLEX

A Condenser material of medium permittivity. For the construction of Condensers having a constant capacity at all temperatures.

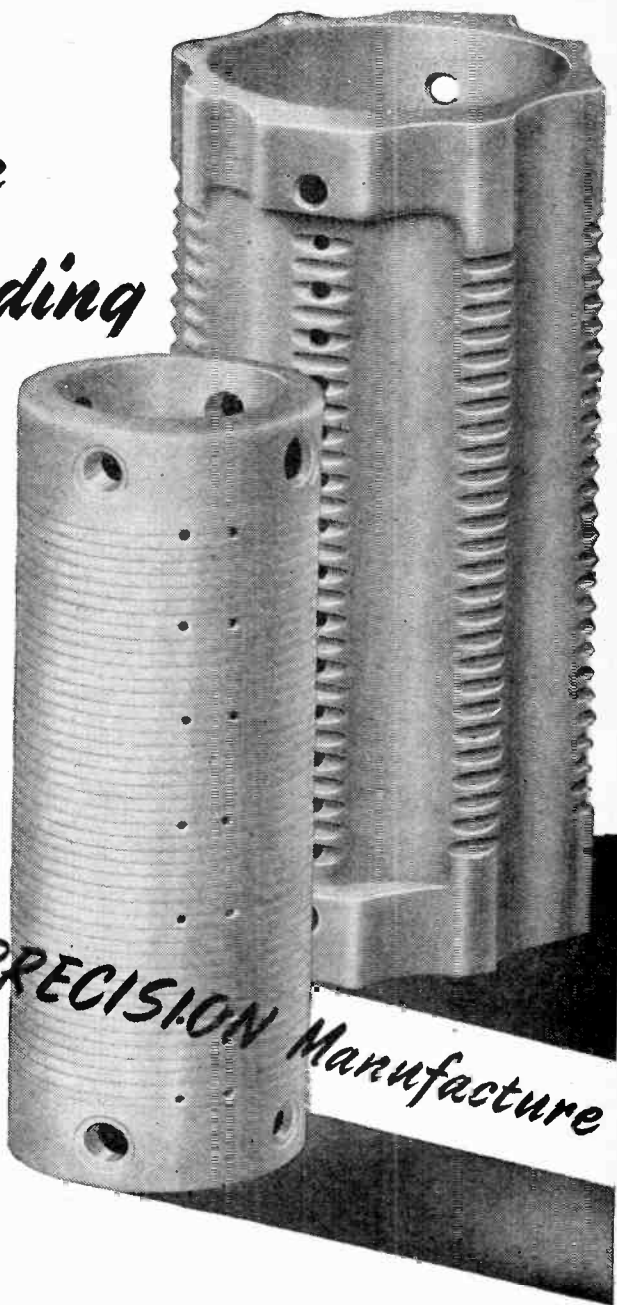

**BULLERS LOW LOSS CERAMICS**

BULLERS LTD., 6, Laurence Pountney Hill, London, E.C.4.  
Telegrams: "Bullers, Cannon, London"

Phone: Mansion House 9971 (3 lines)

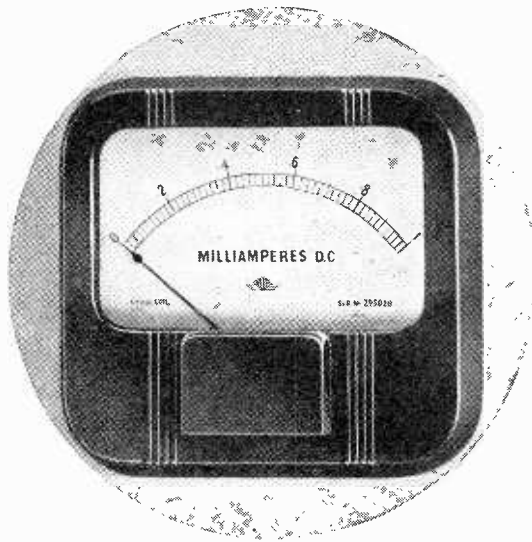

# PULLIN

SERIES 35

## ILLUMINATED DIAL RECTANGULAR INSTRUMENTS

THE Pullin illuminated dial fitment gives even illumination over the whole scale. Being external it cannot cause heating of the movement. It is housed in a metal box on the front cover and can be easily inspected or replaced without the use of tools. The box acts as a reflector and its design and position enhances the appearance of the instrument. The lamp is a 6 V. 3 watt tubular festoon type. The terminals are at the back of the instrument case.

These instruments are available in a wide range of moving coil types to meet every requirement. Full details upon application.



Please address all correspondence to: Dept. J., Phoenix Works  
Great West Road, Brentford, Middlesex. Ealing 0011

## TRANSMITTING TUBE SOCKETS

JOHNSON transmitting tube sockets have been for years the accepted standard. All have heavy sidwiping spring phosphor bronze contacts, cadmium plated.

The No. 211 filament springs are double, to handle heavy filament currents. All have heavy nickel brass shells, supporting the tube by its base rather than the prongs. Percelain bases are of excellent quality low absorption material.

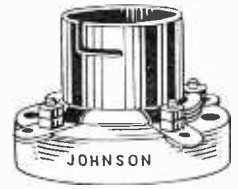

We also have a limited number of a de Luxe Model which are similar to the above transmitting tube sockets, these are fitted with a tube clamping device and earthing lug for base and shell. While stocks of either type are available we offer them at a quarter of List Price . . . ONLY 3/6 EACH.

IF YOU ARE INTERESTED in a TRANSCIEVER or a TRANSMITTER, please see our advertisement on page 26 of the September issue. They are excellent bargains, and we have a few more available.

Send stamp  
for Bargain  
List "W"

**RADIOMART**  
100, HOLLOWAY ROAD, BIRMINGHAM, 1

Telephone:  
Midland  
3254

# ARE YOU A ONE ROOM RADIO LISTENER?

Now that Stentorian Extension Speakers are coming back to the shops the pleasure of listening again becomes complete. Just plug in one of these superb permanent magnet speakers to your set and you can enjoy its clear, pure tone anywhere in the house: sitting-room, kitchen, bedroom, wherever you happen to be. Supplies are still short, but a Stentorian is worth looking for. Ask your local dealer about them.



- PRICES**
- Minor Type MX (for Low Impedance Extension) 29/6
  - Minor Type MC (with Universal Transformer) 35/6
  - Baby Type BX (for Low Impedance Extension) 43/6
  - Baby Type BC (with Universal Transformer) 49/6



# Stentorian

THE PERFECT EXTRA SPEAKER FOR ANY SET

WHITELEY ELECTRICAL RADIO CO. LTD., MANSFIELD, NOTTS.

# METALLISED CERAMICS

for

## Hermetic Seals and Soldered Assemblies

### FREQUENTITE BUSHES

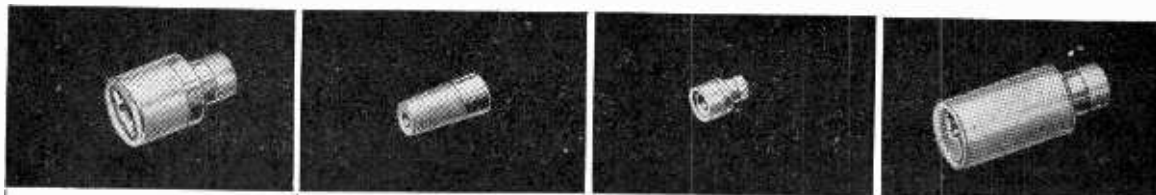

Photographs (above) actual size.  
Drawings not to scale.

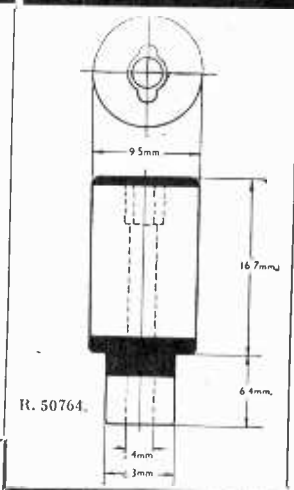
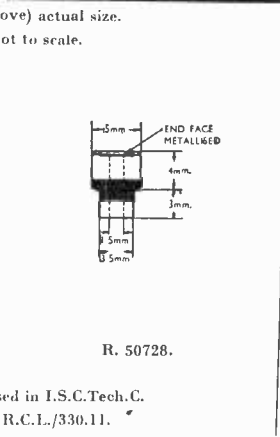
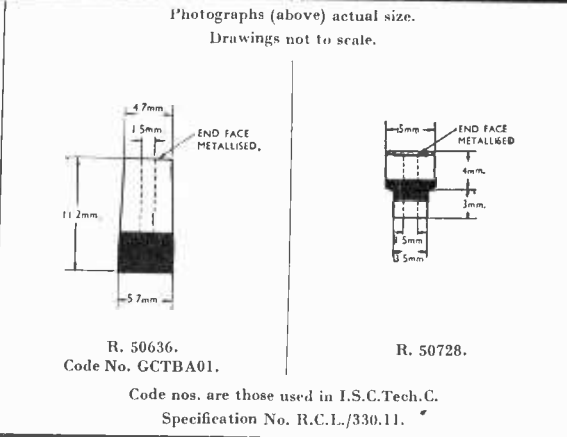
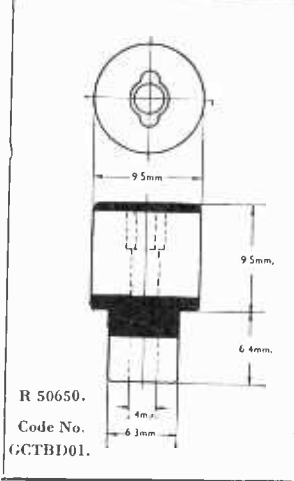

Code nos. are those used in I.S.C.Tech.C.  
Specification No. R.C.L./330.11.

### PORCELAIN BUSHES

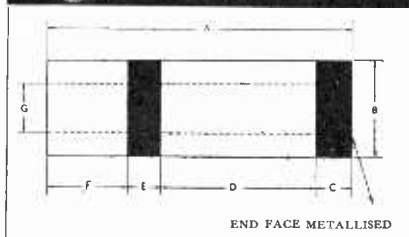
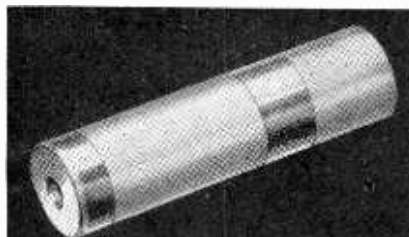

TYPE	CODE	A mms.	B mms.	C mms.	D mms.	E mms.	F mms.	G mms.
R. 50734	GCTBC01	20.3	7.6	3.8	6.4	4.6	5.5	3.0
R. 50768	GCTBC02	20.3	12.7	3.8	6.4	4.6	5.5	5.1
R. 50769	GCTBC03	20.3	15.2	3.8	6.4	4.6	5.5	6.4
R. 50770	GCTBC04	38.1	10.2	5.1	15.7	6.4	10.9	4.1
Q. 2092	GCTBC05	55.9	12.7	6.4	25.4	8.9	15.2	5.1
Q. 1982	GCTBC06	78.7	15.2	6.4	38.1	8.9	25.3	5.1

For full information and prices please write to:

# STEATITE & PORCELAIN PRODUCTS LTD.

STOURPORT-ON-SEVERN, WORCS. T'phone: Stourport III. T'grams: Steatoin, Stourport.



## PINCH EFFECT and its relation to record wear

A maximum of "0004" vertical movement is necessary to overcome the "pinch effect" which has been carefully dealt with in the design of

### The LEXINGTON MOVING COIL PICK-UP

SCIENTIFICALLY ENGINEERED

This is made possible by our patented principles and the introduction of precision watch making mechanics in its construction.

Price £5 plus 25/- P.T.

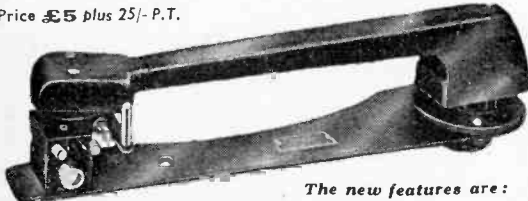

**The new features are:**

- Robust design. Accidental dropping on record will not damage Pick-up.
- Extremely low moment of inertia (80 milligrams total weight of movement).
- Pure sine wave with no harmonic distortion.
- Response curve flat from 30 c/s to 12 Kc/s.
- Automatic needle or sapphire changing opens new fidelity field to the amateur.
- Can be used with normal record changer without fear of damage.

PRE-AMPLIFIERS are also available. Compact design for screwing in cabinet. With or without bass recording characteristic correction. Suitable for use with standard amplifiers.  
POWER AMPLIFIERS, 8, 15, and 30 watts undistorted output. Obtainable from your Local Dealer. Trade enquiries invited.

Send stamp for illustrated brochure giving full technical details and prices.  
● In future all enquiries should be sent to our Works address below where daily demonstrations will also be given.

**COOPER MANUFACTURING CO.**  
17/20, Hanway St. Works, Hanway St., London, W.1. MUScum 9779



## Photo-Electric Cells



Manufacturers of over forty different types of Photo-electric cells from standard ranges to "miniatures" and "specials" designed to meet all requirements in industry and the laboratory, with characteristics and physical dimensions over the widest possible range.

- Multiplier cells for amplification of the primary photo current.
- Geiger Muller tubes for Cosmic Ray research and other applications.
- Quartz cells for use with ultra violet radiation.
- Nitrogen Helium Discharge Lamps.

New Brochure and price list now available on application.

**CINEMA - TELEVISION LTD.,**  
INCORPORATING BAIRD TELEVISION LIMITED  
WORSLEY BRIDGE RD., LONDON, S.E.26

Telephone: Hither Green 4600

Suppliers to ADMIRALTY, MINISTRY OF AIRCRAFT PRODUCTION, MINISTRY OF SUPPLY, ARMAMENT RESEARCH, etc. Manufacturers of Scientific Instruments and Photo-electric cells.

## Simple Arithmetic

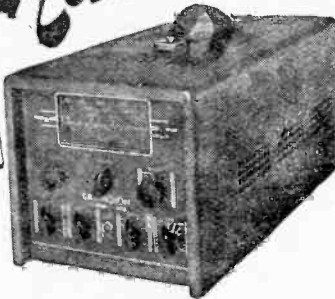

### THE NEW GRAMPIAN MODEL 461 RECEIVER AMPLIFIER

This new high-grade reproducer has been specially designed for use in Small Factories, Hotels, Clubs, Swimming Pools, Municipal Buildings, etc., where it is desired to broadcast Radio or Gramophone Records and provide amplification of speech by use of a microphone. Let us send you further details.

A dual wave-band superheterodyne with Power Amplifier having an output of 15 watts. Provision is made for both pick-up and microphone inputs with separate volume controls and high and low impedance outputs. It is of extremely robust construction in an attractively finished metal case.

# GRAMPIAN

LOUDSPEAKERS

GRAMPIAN REPRODUCERS LTD.,  
Hampton Road, Hanworth, Middlesex. Phone: Feltham 2657

Price List £39-0-0.  
Plus £2-2-0  
Purchase Tax.  
A.C. Mains ONLY

Scientific G.6A.



NEW LOW LEVELS in capacity and attenuation of CO-AX Cables mean new possibilities in electronic equipment design both for the war effort and for the post-war electronic age.

Write for characteristics

**BASICALLY BETTER  
AIR-SPACED**

## CO-AX LOW LOSS CABLES

TRANSRADIO LTD. 16 THE HIGHWAY, BEACONSFIELD, 4-BUCKS.

# LINAGLOW LIMITED

To meet the demand for various parts of the well-known **R.A.F. PORTABLE DINGHY RADIO TRANSMITTER**, which cost approximately £39 to manufacture, we are this month offering the Transmitter in the following sections and components :—

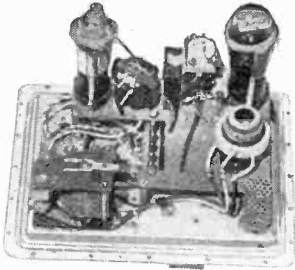

### TOP PANEL

Comprising: Valves 6J7 and 6V6.—Crystal, 500 kc/s. accuracy .025%—Variable Condenser with Neon Radiation Indicator—Litz Wound Coils (Iron Dust Core)—Transformer—H.F. Choke—Various Condensers and Resistors, etc.

PRICE **22/6**

Postage and packing 1/6

Television line scanning output transformers for use with valves PEN46 or AC 6PEN. Price 12/6

Mazda Valves for Televisers, types T41, S.P.41, S.P.42, V.P.41 ..... 12/10  
PEN46, AC 6PEN, U21, 18/3  
DI Diode with holder 8/-

The above prices include purchase tax. Please add 3d. per valve postage.

### WOODEN BOXES

Cost 30/- to manufacture. Ideal for Tool Box or for storage of spare parts. Made of 7/16" plywood with hinged lid. Divided into two sections 12" and 4" wide. Internal dimensions 16 1/2" x 12" x 9 1/2" deep.

PRICE **5/6**

Postage 1/1

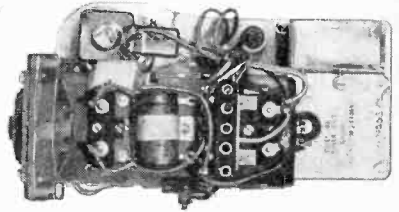

### POWER PACK

Comprising: Hand Generator with handle (300 volts 60 mA. H.T. and 6 volts 2 amp. L.T.)—Voltage Regulator—Smoothing Unit—Relays—Electrolytic

Condenser, etc. PRICE **22/6**

Postage and packing 1/6

LINAGLOW LIMITED, Dept. M.O.70, 34, OSNABURGH ST., EUSTON RD., LONDON, N.W.1 (Nr. Gt. Portland Street Station) Telephone No. EUSTON 8406 (5 lines).

From its unique range of Communications Test Gear  
MARCONI INSTRUMENTS LTD  
can now offer the  
**UNIVERSAL IMPEDANCE BRIDGE**  
TYPE T F 373D

**FOR IMMEDIATE DELIVERY**

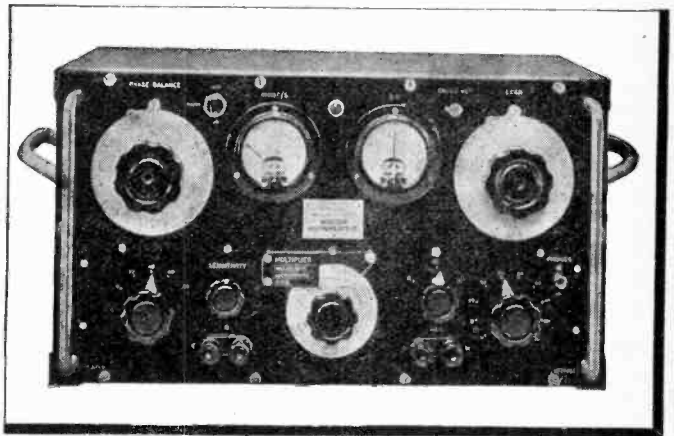

Designed for the direct measurement of inductance, capacitance and resistance over exceptionally wide ranges, the instrument is a product of Marconi pioneer experience in radio engineering.

Full specification available on request.



## MARCONI INSTRUMENTS LTD

ST. ALBANS, HERTS.

Telephone: ST. ALBANS 4323/6

Northern Office: 30 ALBION STREET, HULL. Phone: Hull 16144

Western Office: 10 PORTVIEW ROAD, AVONMOUTH. Phone: Avonmouth 438

# A WIDE RANGE OF OKERIN WAX DI-ELECTRICS

—created in our own laboratories and manufactured in our own works—supplies almost every requirement of Electrical Industry. Grades have been designed for operation under the most severe and varied conditions, and many are resistant to mould and fungus growth.



Special types are evolved as new applications arise, and technical discussion on manufacturers' problems is welcomed.

## ASTOR BOISSELIER & LAWRENCE LTD.,

(Sales Dept). Norfolk House, Norfolk Street,  
London, W.C.2. Telephone: Temple Bar 5927

## NEW ROMAC RADIO & ORAL COMMUNICATION COMBINED

25 Watt, Model 25/HII.

Incorporated Radio Tuning Unit, Provision for Moving Coil or Crystal Microphone and High Impedance Gramophone Pick-up to meet the demand of the present day for High Grade Equipment.

Delivery Ex Stock

Also our Model 25/HI Amplifier for Microphone and Gramophone input only, also with high quality output of 25 watts.

Delivery Ex Stock.

Gramophone Playing Desk Unit in attractive case with lid available with either Amplifier.

## ROMAC RADIO CORPN. LTD.

THE HYDE • HENDON • LONDON, N.W.9

## THE STATIC CONDENSER Co. Ltd.

★ *Manufacturers of  
STATIC  
CONDENSERS*

TOUTLEY WORKS,  
WOKINGHAM, Berks

Telephone: WOKINGHAM 708

Constant Voltage

TRANSFORMERS

LINE VOLTAGE VARIATIONS OF  $\pm 15\%$  REDUCED TO  $\pm 1\%$

TYPICAL SPECIFICATION 190-260 v. 50 c/s

Output Voltage 150 v.  $\pm 1\%$

Max. load 150 watts

Input Power factor over 90%

Prices on application. Write for details.

ADVANCE COMPONENTS LTD.

BACK RD. SHERNHALL ST. WALTHAMSTOW E17. PHONE: WARKSWOOD 43662



# Again published — the Eddystone Short Wave Manual

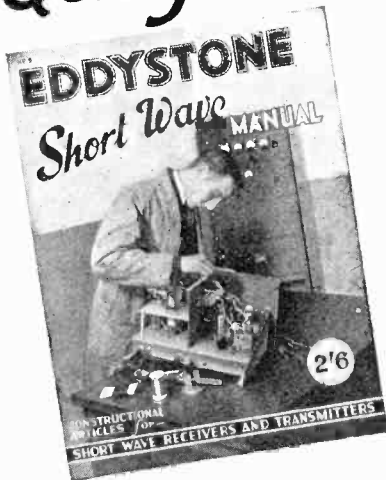

This popular manual of absorbing interest to every Ham and Short Wave Radio constructor will be available at the end of October. The Eddystone Short Wave Manual can be obtained ONLY from authorised Eddystone Dealers.

## WE REGRET—A NOTE OF WARNING

It is our duty to you (and in fairness to all our registered Dealers) to be frank regarding the present supply position of Eddystone Components. In view of to-day's manufacturing difficulties (common to all) we are not finding it easy to meet the demand as quickly as we would wish. We must in the Nation's interest maintain our Export Drive thus leaving only a portion of our output for the Home Market. To avoid disappointment, order your Eddystone Components well in advance. Don't blame your dealer if he cannot fulfil your entire requirements over the counter—he is doing his best for you and we are doing our best for him. You may be sure that we, the manufacturers, are doing everything possible to increase output. Distribution of our products will be made evenly throughout the country—you may not have to wait, but if you do, please be patient.

*(If you do not know your local Eddystone Dealer, we will, if you desire, send you his address. Please send postage. We do NOT supply direct.)*

Published by

**STRATTON & Co., Ltd., Eddystone Works, Alvechurch Road, West Heath, B'ham 31**

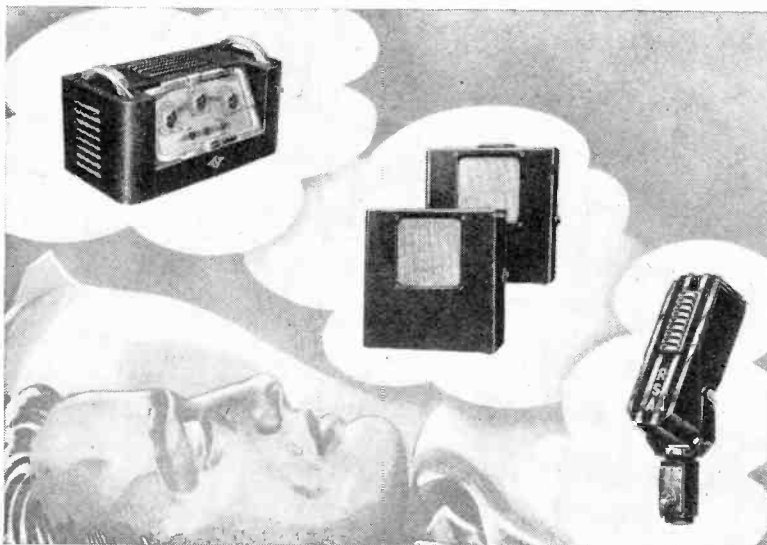

# DREAMS DO COME TRUE . . .

There's been nothing new for you from R.S. for 7 years now—like many others we were actively engaged on the Big Job. But in our few leisure moments we were dreaming of a new factory and a new range of Sound Equipment.

Now our dreams are coming true, we've got our new factory, and the new range is almost ready for you.

Be amongst the first to receive full details of our new equipment—write to-day.

MICROPHONES

LOUDSPEAKERS

RADIO

RADIOGRAMS

AMPLIFIERS

PORTABLE EQUIPMENT



**R.S. AMPLIFIERS, LTD., REYNOLDS ROAD, ACTON LANE, LONDON, W.4. PHONE: CHISWICK 1011-3**

# ROTHERMEL

**HIGH FIDELITY PIEZO - ELECTRIC PRODUCTS**

available from stock.

**PICKUPS**

- MICROPHONES
- HEADPHONES
- THE HUSHATONE
- DEAF AID MICROPHONES
- CONTACT MICROPHONES
- A.C. AMPLIFIERS

Also the new ROTHERMEL GENUINE SAPPHIRE High-Fidelity Gramophone Needle—over 2,000 playings.

Send for Informative Literature on all ROTHERMEL Products.

★ **TWO NEW AMPLIFIERS**

For many years R. A. ROTHERMEL has made intensive research in Amplifier design and we present with confidence two new A.C. Amplifiers, the VR/2 4½-watt and the HG/308 8-watt, which have been specially designed for use in connection with all types of Crystal Microphones and Crystal Pickups. They are compact, robust, and represent the ultimate in design, workmanship, material, and quality of reproduction.

Write for Bulletin.

**R. A. ROTHERMEL LTD.,**

ROTHERMEL HOUSE, CANTERBURY ROAD, KILBURN, N.W.6.  
Telephone: MAIDA VALE 6066 (6 lines).

**LABGEAR**

**CRYSTAL CALIBRATOR**

● for **FREQUENCY STANDARDS** in ●  
RADIO SERVICE WORKSHOPS,  
LABORATORIES, or "HAM SHACKS"



**ABRIDGED SPECIFICATION OF ABOVE UNIT List No. B2015 WW**

Provides Crystal check points at 100 Kc/s or 1 Mc/s intervals up to 50 Mc/s with an accuracy of .015% at 100 Kc/s points and .02% at 1 Mc/s points. Self contained Power Supply from 200-250 v. 50 cycle input. Size 11½×8×9 ins. high. Finish is Black Wrinkle with metal fittings Polished Nickel Plated.

Phone

**LABGEAR**

Grams

2494 (2 Lines)

Labgear, Cambridge

● **WILLOW PLACE, CAMBRIDGE, ENGLAND** ●

Write now for our lists of High Class Test Equipment

consult us on your

**PLASTIC PROBLEMS**

**COSMOCORD LTD · ENFIELD**

*Frequency compensated*

**A.C. VOLTAGE STABILISATION**

- ★ ±1% change in mains frequency reduced to ±0.05% in output voltage.
- ★ ±1% change in supply voltage will not change output by more than ±0.04%.
- ★ Output voltage held within the extreme limits of ±0.14% for simultaneous variations of ±6% in voltage and ±2% in frequency.
- ★ Visually perfect waveform.
- ★ Made in sizes of 12, 24, 60, 120, 240 and 480 VA. Input 190/260 volts, 50 c/s. Output voltage any desired value.



**"STABILISTOR"**

Type "B"

Please write for E.E.2 to :-

WESTINGHOUSE BRAKE & SIGNAL CO., LTD.,  
82, York Way, King's Cross, London, N.1.

# ERSIN MULTICORE

Multicore Solder contains 3 cores of extra active non-corrosive Ersin Flux. No extra flux is required and joints can be readily made on oxidised surfaces. The three cores of Ersin Multicore ensure rapid melting and flux continuity, thus speeding up soldering operations and eliminating waste.

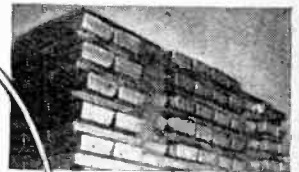
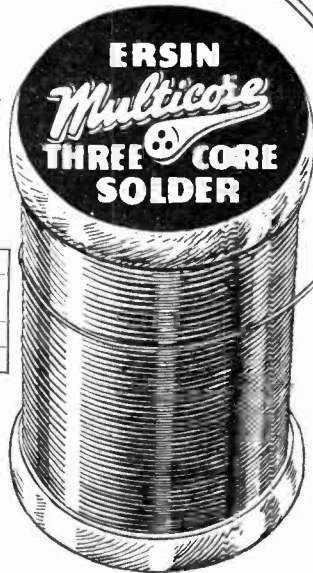

Purest tin and lead are used in Multicore Solder.



High Precision standard of soldered joints obtained.



Multicore being made in gauges between 10 & 22 S.W.G.

NOMINAL 1-lb. REELS HIGH TIN CONTENT PRE-WAR QUALITY.				
Catalogue Reference No.	Alloy Tin/Lead	S.W.G.	Approx. Length per nominal 1-lb. reel.	Price per nominal 1-lb. reel (subject).
16014	60/40	14	64 feet	6.-
16018	60/40	18	178 feet	6.9

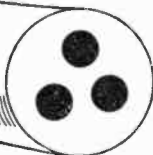

MULTICORE SOLDERS LTD., MELLIER HOUSE, ALBEMARLE STREET, LONDON, W.1  
Tel. REGent 1411 (P.B.X. 4 lines)

## TECHNICAL DATA that *Speaks for itself!*

Here is one of the most popular of the Goodmans Loudspeakers now available—the T2/1205/15. A medium heavy duty reproducer with a frequency response ideal for Public Address systems and high power radiogramophones. A robust, precision made instrument with a high degree of reliability under all conditions.

- BRIEF TECHNICAL DATA**
- Overall Diam. 12 5/8" .....
  - Fundamental Resonance .....
  - Max. Power Capacity .....
  - Voice Coil Imp. ....
  - Flux Density .....
  - Net weight .....
  - Overall Depth 6 3/4" .....
  - 75 c.p.s. ....
  - 12 w. peak A.C. on 4 ft. baffle (15 w. horn loaded) .....
  - 15 ohms at 400 c.p.s. ....
  - 13,000 gauss .....
  - 11 1/2 lb. ....

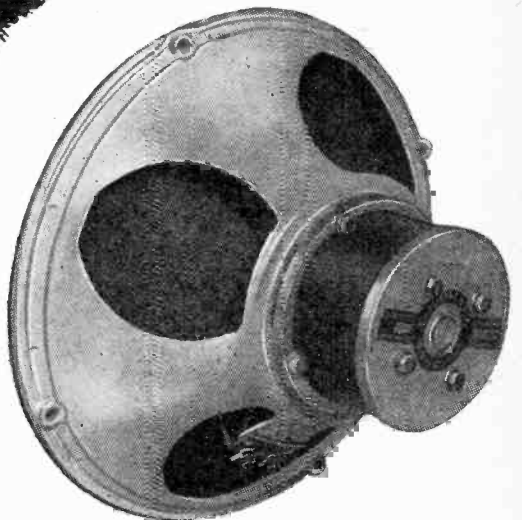

**GOODMANS** Type T2/1205/15  
*Loudspeaker*

Price £6 15s. (Subject)  
NOW AVAILABLE

GOODMANS INDUSTRIES LTD · LANCELOT RD · WEMBLEY · MIDDXX

# Coil winding MACHINES

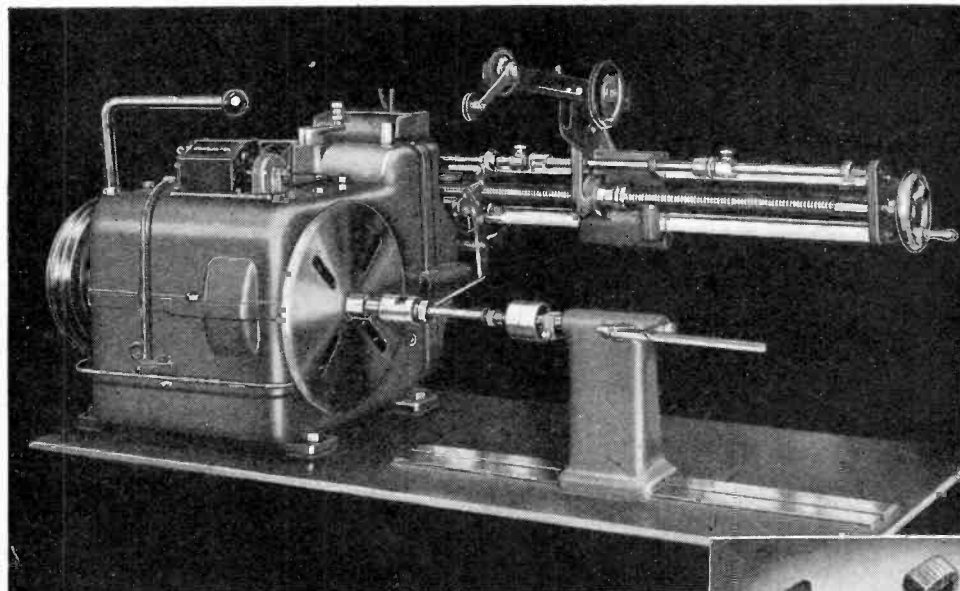

A representative group of coils wound on the Type MW machine.

## TYPE MW MACHINE Suitable for 11 to 47 S.W.G.

Wire gauges from 11 to 47 S.W.G. can be wound on the Neville's Type MW automatic coil winder. Such a wide range of coils would normally require three different sizes of machine. The very complete specification includes a pre-determined re-set revolution counter registering up to six figures, three speed geared drive, and ball bearings throughout. Coils of 12" maximum diameter from  $\frac{1}{16}$ " to 10" in length are within its capacity, and faceplate speeds from 283 to 1435 R.P.M. are obtainable. An experienced staff of highly skilled technicians is always prepared to give individual attention to coil winding problems. Your enquiries are invited.



# NEVILLE'S (LIVERPOOL) LTD

THE SIMMONDS TOWER · GREAT WEST ROAD · LONDON  
A COMPANY OF THE SIMMONDS GROUP



# Wireless World

Radio and Electronics

36th YEAR OF PUBLICATION

## OCTOBER 1946

Proprietors:  
ILIFFE & SONS LTD.

Managing Editor:  
HUGH S. POCKO,  
M.I.E.E.

Editor:  
H. F. SMITH

Editorial, Advertising  
and Publishing Offices:

DORSET HOUSE,  
STAMFORD STREET,  
LONDON, S.E.1.

Telephone:  
Waterloo 3333 (50 lines).

Telegrams:  
"Ethaworld, Sedist, London."

△

PUBLISHED  
MONTHLY

Price: 1/6

(Publication date 26th  
of preceding month)

Subscription Rate:  
Home and Abroad  
20/- per annum.

MONTHLY COMMENTARY .. .. .	315
FREQUENCY MODULATION TESTS .. .. .	316
ASTRONOMICAL RADAR .. .. .	
By Arthur C. Clarke .. .. .	321
H.M.S. BOXER .. .. .	
By G. M. Bennett .. .. .	324
NOISE IN PULSE MODULATION .. .. .	
By Thomas Roddam .. .. .	327
TEST REPORT: R.G.D. MODEL 10466 .. .. .	330
DESIGN DATA (8): Video Amplifier H.F. Response: Part II .. .. .	333
VALUES .. .. .	
By "Cathode Ray" .. .. .	335
HEARING-AID RECEIVERS .. .. .	338
WORLD OF WIRELESS .. .. .	339
OUTWARD FORM .. .. .	342
UNBIASED .. .. .	
By Free Grid .. .. .	344
LETTERS TO THE EDITOR .. .. .	345
SHORT-WAVE CONDITIONS .. .. .	
By T. W. Bennington .. .. .	347
RANDOM RADIATIONS .. .. .	
By "Diallist" .. .. .	348
RECENT INVENTIONS .. .. .	350

Branch Offices:

COVENTRY:  
8-10, Corporation Street.  
Telephone: Coventry 5210.

Telegrams:  
"Autocat, Coventry."

BIRMINGHAM:

King Edward House,  
New Street.

Telephone:  
Midland 7191 (7 lines).

Telegrams:  
"Autopress, Birmingham."

MANCHESTER:

260, Deansgate, 3.

Telephone:  
Blackfriars 4412 (4 lines).

Telegrams:  
"Iliffe, Manchester."

GLASGOW:

26B, Renfield Street, C.2.

Telephone: Central 4857.  
Telegrams: "Iliffe, Glasgow."

△

*As many of the circuits and apparatus described in these pages are covered by patents, readers are advised, before making use of them, to satisfy themselves that they would not be infringing patents.*



## ... but **WEARITE** Stratosil Sealed VIBRATORS OPERATE EFFICIENTLY UNDER ALL CLIMATIC CONDITIONS

Come rain, come shine, or any other climatic condition, Wearite 'Stratosil Sealed' Vibrators will continue to operate without trouble. Why? Oh! We designed and built them with just that end in view, and after tests, specified the following as essentials . . .

- All steel construction—even the rivets—uniform expansion under temperature extremes ensured.
- Vibrator acoustically and electrically shielded by Metal Can, sponge rubber lined.
- Precious metal driving contacts—non-tarnishable—ensure starting under the lightest pressures and voltages.
- Contacts ground almost to optical limits.
- Stack assembly—mica and steel only used.
- Base sealed by the WEARITE Stratosil process.
- Always keep going . . .



## STRATOSIL Sealed VIBRATORS

SEND TODAY FOR FURTHER DETAILS, AND REMEMBER, WE ALSO MAKE SOME OF THE BEST TRANSFORMERS, COILS AND SWITCHES.

**WRIGHT and WEAIRE LIMITED**

HIGH ROAD · TOTTENHAM · LONDON · N.17 · TELEPHONE: TOTTENHAM 3847-9

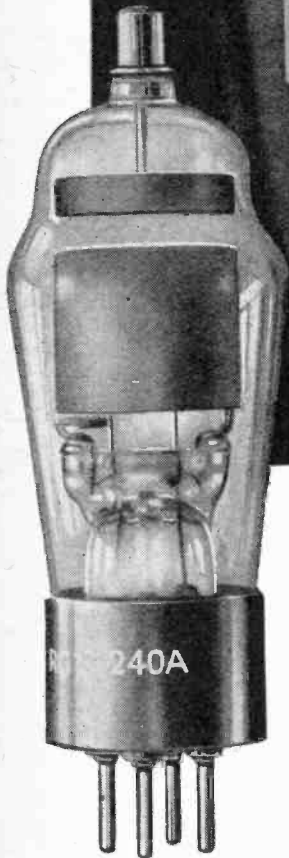

### RG1-240A

#### MERCURY VAPOUR RECTIFIER

PEAK INVERSE VOLTAGE.....4,700 V  
 MEAN ANODE CURRENT..... 250 mA  
 TWO VALVES IN A SINGLE-PHASE FULL-WAVE  
 CIRCUIT WILL GIVE 1,500 VOLTS AT 500mA  
 FILAMENT VOLTAGE..... 4.0 V  
 FILAMENT CURRENT..... 2.7 A APPROX.

## Speaking of POWER SUPPLIES

Designers need no introduction to the Mercury Vapour Rectifier. Its advantages are quickly appreciated when good regulation in power supply is of paramount importance. But Mullard adds something else to consistent regulation and low initial cost. When manufacturing methods and processes keep pace with development, reliability in service is a fore-gone conclusion. This X-ray of the Mullard RG1-240A shows the internal construction of yet another valve with a proved performance.

For further developments watch



# Mullard

## THE MASTER VALVE

Technical data and advice when using the RG1-240A Mercury Vapour Rectifier can be obtained from:  
 THE MULLARD WIRELESS SERVICE CO. LTD., TRANSMITTING & INDUSTRIAL VALVE DEPT.,  
 CENTURY HOUSE, SHAFTESBURY AVENUE, LONDON, W.C.2.

# Wireless World

Radio and Electronics

Vol. LII. No. 10

OCTOBER, 1946

Price 1s. 6d.

## Monthly Commentary

### *Over-limited Broadcast Licences*

WE have long considered the Post Office broadcast receiving licence to be a rather extraordinary document. But this view does not seem to be widely held; at any rate, protests against the terms in which it is couched are rare. That, perhaps, is in keeping with the British belief that it is a waste of time even to read official documents; their meaning is certain to be obscure, and in any case protest will be without avail.

Now, at last, spurred apparently by changes that have been made in the new £1 licence, a reader, whose letter is printed elsewhere in this issue, takes vigorous exception to some of the provisions made in it. He draws attention to the fact that, although the licensee is authorized "to work apparatus for wireless telegraphy," the apparatus is to be used merely for receiving "messages by telephony . . . sent for general reception by authorized Broadcasting Stations or sent from authorized experimental stations in connection with experiments carried out by the Licensee."

The first of the objections raised—very reasonably—by our correspondent is that, by implication at least, the reception of telegraphy is not covered by the licence. Now everybody knows that a vast number of messages are in fact transmitted telegraphically for general reception, being actually addressed to CQ (all stations). If in fact the broadcast licence does not cover telegraphy, what kind of licence is needed?

The use of the phrase "authorized Broadcasting Stations" is at first sight a more serious matter. Does it mean that we are debarred from following at first-hand the lively political situation in Ruritania if the local station happens to be forcibly seized by the Patriots Party, thus presumably becoming unauthorized? Or, coming nearer to reality, is it intended to pave the way for a ban on listening to foreign advertising programmes addressed to British listeners?

Although *Wireless World* deplores the general

terms of the licence, we cannot share the evident view of our correspondent that there is something sinister or "totalitarian" behind the changes in the wording. The changes themselves are, in fact, quite insignificant; the phrases to which exception is taken appeared in even more categorical terms on the back of the former 10s licence under the heading of "Conditions." Nothing that appears on the new licence should be linked with recent political happenings.

Instead of applying some such word as "totalitarian" to the wording of the licence, we would use the much less sinister slang term "bossy." The whole document is a fine example of that regrettable and ever-growing tendency of officialdom to exceed its authority and, in the current phrase, to "push people around." There are many clauses to which exception can be taken; for example, what business is it of the Post Office if we make a direct connection between our receiving aërials and the supply mains, or if we sling the same aërials precariously above high-tension lines? Both these practices are admittedly reprehensible, but the Post Office has no authority for the specific and more or less dictatorial prohibitions that appear on the licence. Instead of direct prohibitions, recommendations might properly have been made.

Perhaps the kindest interpretation is that the licence was drafted by an over-cautious official whose aim was to safeguard his department from litigation. One can easily imagine that the same official, if called upon to prepare an excise licence for the distillation of potable spirit, would have been at pains to point out that nothing in the document conferred authority to contravene the laws against drunkenness.

The broadcast licence should be re-drafted by someone with a more lively appreciation of his duties as a servant of the public. In particular, the reception of broadcast telegraphy should be regularized.

# FREQUENCY MODULATION TESTS

## Results of B.B.C. Field Trials

THE use of frequency modulation at high carrier frequencies has been widely adopted in the U.S.A. for broadcasting and it has received so much publicity that many have formed the opinion that the more commonly used amplitude modulation is obsolete. It is widely believed that F.M. reduces noise of all kinds, including circuit and valve noise, car ignition and electrical machinery interference, as well as atmospheric; it is often claimed, too, that it improves the transmitter efficiency, increases the service area of a station and eliminates fading. Much stress has also been laid on an alleged improvement in the quality of reproduction obtainable.

In some cases the claims made for frequency modulation have been unquestionably exaggerated and in order to determine its capabilities the B.B.C. decided to carry out actual trials in this country. The results of these trials are published in the *B.B.C. Quarterly* and are of considerable importance.

The first tests were carried out at 45 Mc/s with two 1-kW transmitters, one being installed at Alexandra Palace and the other near Oxford. One of them was later removed to Moorside Edge for tests in hilly country. The tests were afterwards repeated with a frequency of 90 Mc/s. The tests comprised propagation trials (measurements of field strength *versus* distance for both horizontal and vertical polarization); fading measurements; a comparison of F.M. and A.M.; signal-noise ratio measurements, and practical listening tests.

With the conventional amplitude modulation the frequency of the carrier is a constant and its amplitude is varied in accordance with the intelligence to be conveyed. Variations of loudness in a musical programme, for instance, alter the magnitude of the changes of carrier amplitude, but the different musical frequencies are conveyed by different rates of

change of carrier amplitude. With a 1,000-c/s tone as modulation the carrier amplitude varies from a maximum to a minimum and back again 1,000 times a second, and with a 2,000-c/s tone it varies 2,000 times a second and so on. If the loudness of the tone is altered, the magnitudes of the maxima and minima vary until a minimum corresponds to the disappearance of the carrier at that instant. This represents 100 per cent modulation. Now with frequency modulation the



Experimental frequency modulation transmitter used at Alexandra Palace for the trials

carrier amplitude is constant at all times and it is the frequency which is varied to convey intelligence. Any variation of the loudness of the intelligence alters the amount by which the frequency changes and different modulating frequencies are conveyed by different rates of change of carrier frequency. Thus, with a 1,000-c/s tone the carrier frequency varies from a maximum frequency to a minimum and back again 1,000 times a second, but the amount of the variation depends on the loudness of the tone. With a 2,000-c/s tone the variations take place 2,000 times a second.

The theoretical limit to the amount of the variation of frequency occurs when the frequency swing is from zero to twice the carrier frequency. One could call

this 100 per cent modulation. It is, however, of no practical importance for in the first place zero frequency cannot be radiated and in the second the frequency spectrum would be enormous.

Practically speaking, there is no limit to the magnitude of the frequency variation as long as it is small compared with the carrier frequency. The maximum deviation of frequency is usually fixed by considerations of band-width and 100 per cent modulation is considered as occurring when this deviation is reached.

In the U.S.A. this maximum deviation has been standardized at  $\pm 75$  kc/s. In fact, with weak signals there is an optimum deviation for the best signal/noise ratio but it does not appear to be very critical, and the B.B.C. conclusion is that there seems to be no object in changing from the value of  $\pm 75$  kc/s. This deviation was adopted in their tests.

In a frequency-modulation re-



ceiver the modulation is usually extracted by means of a discriminator. This is essentially a circuit which provides an output voltage proportional to frequency when fed with an input of constant amplitude. The frequency deviations of the input are thus converted to amplitude variations of output. The discriminator and detector are bound up together and provide the A.F. signal from the F.M. input.

Now all normal forms of noise in reception consist of voltages varying in amplitude, and with amplitude modulation relatively little can be done to eliminate them. When the noise peaks are of large amplitude and of short duration they can be reduced by means of limiters which cut off everything above the signal level, and much ingenuity has been expended in the design of such limiters. Their use under proper conditions can give a very considerable reduction of certain types of noise, but they do little or nothing to reduce valve and circuit hiss.

Frequency modulation offers great possibilities of noise reduction because the noise, being in the form of amplitude changes, is of different character from the modulation. The use of an amplitude limiter has no harmful effect on the F.M. signal and it substantially prevents the amplitude changes of noise from reaching the discriminator and detector circuits.

**Phase Modulation**

However, it must not be supposed that the complete elimination of all noise is possible. Noise can phase-modulate the signal in some degree and will then be passed, and there are various other ways in which even with a perfect limiter noise can be combined with the signal so that in some degree it is passed through to the discriminator.

The B.B.C. tests have shown that in the case of receiver noise—that is, valve and circuit hiss—frequency modulation is about 25 db better than amplitude modulation. A satisfactory service can be obtained with a field strength of 50μV/m as compared with 900μV/m for A.M. For a high quality, very low noise, ser-

vice F.M. would need about 200μV/m.

In the case of external noise, F.M. has still a considerable advantage over A.M. Atmospherics are in any case considerably less on frequencies above 45 Mc/s than on the relatively low frequencies normally used for broadcasting, however, and this is also true of some kinds of interference from electrical machinery. When the advantage of F.M. is added, the net improvement is considerable. Car ignition systems prove the most important source of external noise at high frequencies, and in this connection it is worthy of note that it is extremely rare to find interference caused by military vehicles. These are all fitted with suppressors and one must conclude that their universal adoption would considerably increase the service area of a station.

However, the use of F.M. is a considerable improvement over A.M. although it by no means eliminates ignition interference completely. It has been found that the polarization of the radiated signal has a marked effect and that horizontal polarization is distinctly better than vertical. This effect has been

at which a motor car must be for substantially complete inaudibility of interference under conditions of low ambient acoustic noise. It is concluded that in urban areas with frequencies around 45 Mc/s, a field strength of 5 mV/m would be needed for a practically noise-free service. With vertical polarization some 15 mV/m would be necessary.

**Polarization**

So far as propagation is concerned the tests have shown very little difference between horizontal and vertical polarization. In some cases of reception behind hills each has proved better than the other; in one location one may be the better while in a different place the other is to be preferred. Reflections from aircraft can be troublesome and have been noticed to be more serious with horizontal than with vertical polarization.

To sum up, the reduction of ignition interference demands the use of horizontal polarization while the minimization of aircraft reflections calls for vertical; there is little or nothing to choose between them on a purely propagational basis. The indication is that horizontal polarization would

**TABLE I—RANGE OF IGNITION INTERFERENCE**

Field Strength 45 Mc/s Half-wavelength dipole 30 feet above ground (μV/m)	Extinction Distance		
	F.M.		A.M.
	Horizontal polarization (yards)	Vertical polarization (yards)	Horizontal polarization
50	200	200	At 100 yards the ignition was very disturbing, but merged into the set noise which was very high. As above, but less disturbing. Perceptible at 100 yards but merging into the set noise. 190 yards 120 ,,
100	150	200	
300	80	120	
500	60	120	
1000	40	80	
5000	25	50	

found also at 90 Mc/s, and is confirmed by American tests.

The relative performances of F.M. and A.M. at 45 Mc/s in respect of ignition interference are indicated in Table I. The first column shows the field strength of the wanted signal and the other columns show the distances

be preferred at the present time, but that if all vehicles were fitted with ignition suppressors vertical would be more suitable.

Ground contours are the chief factors affecting propagation and the nature of the soil is not of great importance. It is necessary to site the transmitter on high

ground, for hills cast shadows of low field strength and, in general, reception in valleys is less good than on high ground. The height of the receiving aerial is important and the field strength is approximately proportional to its height. In the B.B.C. tests a receiving aerial height of 30ft was used.

Frequency has an effect on all this and at 90Mc/s the shadows cast by hills are more marked. The kind of variation that occurs is well brought out by Fig. 1, which shows the ground contour between Alexandra Palace and Woburn together with the field strengths actually observed. The smooth curve represents the ideal theoretical field strength.

It will be observed that the measured curve follows the ideal in its general trend but has marked variations. The effect of hills is well brought out; thus, at Dunstable a field strength of some  $750 \mu\text{V/m}$  is observed on high ground, but on the low ground just to the north it drops to around  $50 \mu\text{V/m}$ .

Fading does not usually occur at distances of less than 50 miles from the transmitter, but can be appreciable at longer ranges. The mechanism is different from that at lower frequencies and in general selective fading does not occur, there being only a more or less general variation of signal strength. It is brought about chiefly by changes in those conditions in the lower atmosphere which affect propagation. They are mainly temperature and humidity and they affect the amount of refraction which occurs. The latitude and the

presence of land or sea beneath the transmission path also have an effect.

In addition, "bursts" may occur at ranges of over 100 miles. They last for a very short time and are thought to be caused by reflections from ionic clouds surrounding meteors. They are of no use, but may result in interference from distant stations.

Although selective fading as such does not occur, an analogous effect is observed when the signal can reach the receiver by two or more paths, such as by reflections

a first-class urban service is taken as needing a field strength sufficient to overcome practically all ignition interference, and a second-class service, one with a field strength sufficient to overcome most of such interference. These are field strengths of  $5 \text{ mV/m}$  and  $1 \text{ mV/m}$  respectively, but in rural areas it is considered that fields of  $200 \mu\text{V/m}$  and  $50 \mu\text{V/m}$  are adequate for first- and second-class services.

It is interesting to note that the primary service area of transmissions on 90 Mc/s is rather greater

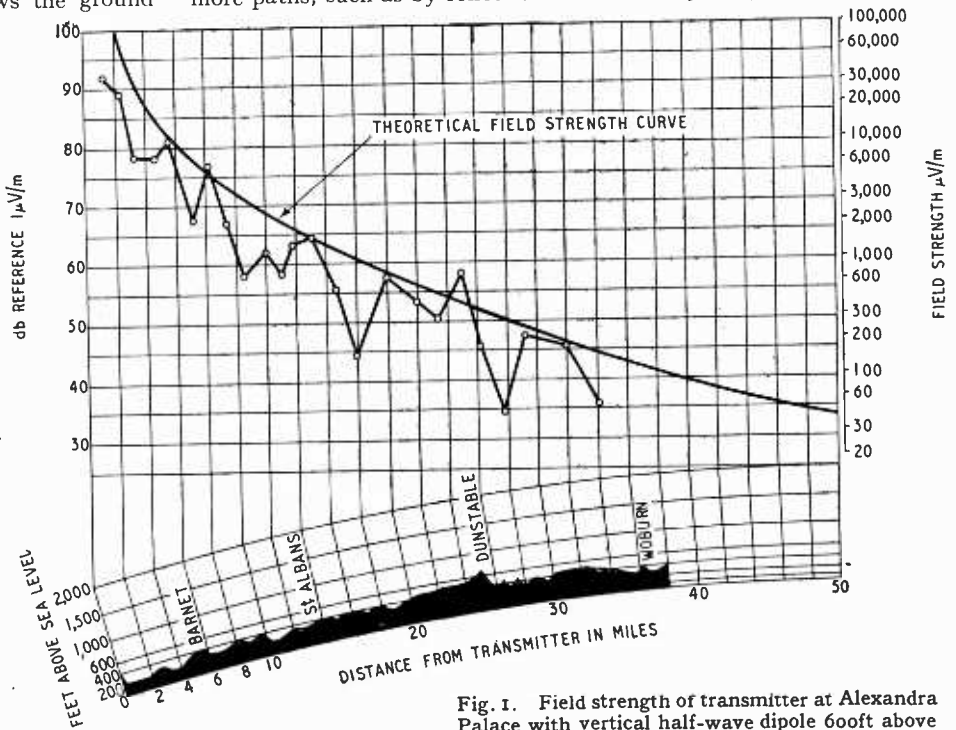

Fig. 1. Field strength of transmitter at Alexandra Palace with vertical half-wave dipole 600ft above sea level and an aerial power of 1 kW at a frequency of 90.3 Mc/s. The receiving aerial had a height of 30ft. The smooth curve shows the theoretical field strength.

from mountains or high buildings. It results in distortion, but is important only when the strengths of the signals from the different paths are of the same order and when the path difference exceeds about one mile.

Distortion of this type was noted on only one or two occasions during the trials and was eliminated by moving the aerial a few feet.

It is difficult accurately to estimate the service area at high frequencies, but Tables II and III show what is expected. In these

than on 45 Mc/s, although the secondary service area is smaller. This is largely because of the lower level of ignition interference at the higher frequency.

An advantage often claimed for F.M. is the "capture effect," as a result of which an unwanted signal is suppressed by a stronger wanted one. It is often said that the latter must be only 6db greater for the effect to be evident. The B.B.C. tests show that it must be 10db stronger to avoid intelligible interference, 20 db for a just tolerable level of

interference and 30db for its complete elimination.

With amplitude modulation and common-wave working 46 db is needed for substantially no interference when the transmitters

an inherently high-fidelity system. This is largely because a comparison is made between a wide-band F.M. system on high frequencies and a narrow-band A.M. system on the medium waveband.

when the field strength becomes low. As F.M. gives a lower noise level than A.M., this means that the full band-width can be retained for greater distances from the transmitter and hence it can

TABLE II—SERVICE AREAS FOR 45 Mc/s (Horizontal polarization)

Height of transmitting aerial above surrounding country (Feet)	No. of aerial stacks	Aerial gain in field strength	Aerial power (kW)	Field-strength multiplier from 1 kW with single dipole	Radius of service area (miles) Receiving dipole aerial 30ft above ground			
					5mV/m 1st class urban service	1mV/m 2nd class urban service	200μV/m 1st class rural service	50μV/m 2nd class rural service
					1000	8	2.8	50
500	8	2.8	50	20	26	44	66	86
500	8	2.8	10	9.0	19	35	55	75
200	4	2.0	5	4.5	9	18	34	52
200	4	2.0	1	2.0	6	13	25	41
100	2	1.4	0.25	0.7	2.5	6	12	30

are radiating different programmes, but 15 db when the programmes are the same. For a second-class service this can be reduced to 10db.

With common-wave operation and separate programmes, therefore, F.M. is about 16-20 db better than A.M. for a first-class service, but with a common programme the condition reverses and A.M. is about 15 db better than F.M.

So far nothing has been said about quality of reproduction,

In the latter case the number of channels is so great that the avoidance of interference precludes the retention of modulation frequencies over about 4,500 c/s, except in the immediate neighbourhood of a transmitter where the field strength is sufficient to swamp interference. At high frequencies this limitation of band-width is not necessary and it is as practicable to transmit and receive as wide a band of modulation frequencies with A.M. as with F.M.

provide a greater service area in which a given standard of quality can be maintained. In this practical sense, therefore, F.M. can truly be said to lead to higher quality than A.M.

Amplitude distortion can occur with F.M. just as with A.M. but in different ways. With the latter it occurs in the detector and through non-linearity of the pre-detector valves. With F.M. it occurs through an asymmetrical resonance curve and its avoidance demands not only a symmetrical

TABLE III—SERVICE AREAS FOR 90 MC/S (PROVISIONAL) (Horizontal polarization)

Height of transmitting aerial above surrounding country (Feet)	No. of aerial stacks	Aerial gain in field strength	Aerial power (kW)	Field strength multiplier for 1 kW with single dipole	Radius of service area (miles) Receiving dipole aerial 30ft above ground			
					2mV/m 1st class urban service	500μV/m 2nd class urban service	200μV/m 1st class rural service	100μV/m 2nd class rural service
					1000	8	2.8	25
500	8	2.8	10	9	26	38	49	57
200	4	2.0	5	4.5	13	23	30	38
200	4	2.0	1	2.0	9	17	23	30
100	2	1.4	0.75	0.7	5	8.0	12	17

and many of the effects of propagation would apply equally to amplitude modulated transmissions. It is probably in respect of quality that the most absurd claims have been made for F.M. and it has often been boosted as

Taking a fair basis of comparison, therefore, there is nothing to choose between the two systems on the score of the audio-frequency response. However, considerations of receiver noise will dictate a decrease of band-width

resonance curve but precise tuning of the receiver. The attainment of this last may cause some difficulties with unskilled operators, and it is suggested that quartz-crystal control of the local oscillator might be a solution.

It is often said, too, that the fact that there is no upper limit to the modulation depth in the same sense as with A.M. permits a greater volume range to be handled. This is very closely tied to the signal/noise ratio, however, and is true only if the comparison be made for similar ratios at the minimum modulation depth. If advantage is taken of the improved signal/noise ratio of F.M. to increase the service area, then the volume range is not increased.

As used in the U.S.A. it is customary to employ pre-emphasis in the transmitter and de-emphasis in the receiver. This means that the A.F. response is made to rise with frequency at the transmitter and to fall with frequency by an equal amount at the receiver. In this way a further improvement in the signal/noise ratio is obtainable; a theoretical improvement of as much as 15 db has been claimed with a pre-emphasis circuit of 100  $\mu$ sec time-constant.

In the B.B.C. trials a 12-db reduction of receiver noise and a 6.5-db reduction of ignition interference was found. However, it became necessary to reduce the modulation depth, in some cases as much as 12 db, and more generally by 6.5 db. This reduced the gain through pre-emphasis to 5.5 db in the case of set noise and to zero for ignition interference.

With a time-constant of 50 $\mu$ sec, receiver hiss and ignition noise were reduced by 7.5 db and 4.5 db respectively and called for a reduction of modulation depth of 3 db only. This made the true gains 4.5 db and 1.5 db. This value of time-constant is preferred to the American standard of 75 $\mu$ sec and was used in the tests described earlier.

In addition to the measurements, comparative listening tests were carried out. Simultaneous transmissions of the Home programme were carried out from Alexandra Palace from 7 p.m. to 10.30 p.m. each evening from June 11th to October 10th, 1945, the F.M. transmissions being on 46.3 Mc/s and the A.M. on 41.5 Mc/s. The F.M. power was 800 watts and the A.M. 1.5-2 kW and with a more efficient aerial. Vertical aerials were used.

Reports were received of recep-

tion up to 120 miles and all listeners able to compare the two transmissions were unanimously in favour of F.M. Some of them commented on the silent background of F.M. Car ignition interference was the most serious source of irritation and some listeners were disappointed with F.M. in this respect.

Later transmissions were made on 90.3 Mc/s with a power of 500 watts and the service was found satisfactory, in some cases being better than at the lower frequency.

An examination of pulse modulation was also made, but the conclusion was reached that F.M. is more suitable for broadcasting. The general conclusions of the B.B.C. report are as follows:—

1. The use of ultra-short waves for broadcasting would relieve the present congestion in the medium and long wavebands as soon as a sufficient number of suitable receivers were in the hands of the public.

2. The use of frequency modulation on ultra-short waves would immediately and considerably extend the area of noise-free, high-quality reception.

3. A reasonable number of frequency-modulated ultra-short wave transmitting stations could be arranged to provide a service throughout the United Kingdom.

4. The increased cost of a broadcast receiver incorporating an ultra-short-wave F.M. band is unlikely to be excessive. It seems probable that with suitable development the performance of F.M. receivers could be improved and the cost reduced.

5. It is thought that frequency modulation would be superior to pulse modulation for providing a high-quality broadcasting service in this country, even taking into account the possibility of using a multi-channel system, because pulse modulation requires a wider band width than frequency modulation to realize a given improvement in noise suppression over amplitude modulation.

6. For an ultra-short wave F.M. service in this country, the following characteristics are thought to be optimum: maximum deviation, 75 kc/s; pre-emphasis, 50  $\mu$ sec; carrier channel spacing, 200 kc/s (400 kc/s between transmitters serving the same geographical area).

## INDUSTRIAL R.F. HEATER

DESIGNED for operation under factory conditions this new G.E.C. 25-kW generator makes use of two ACT16 valves in push-pull and is available with output frequencies of 2 to 15 Mc/s. It may be used for dielectric heating or for surface hardening by eddy currents. Typical work capacities are 12lb of plastic material to moulding tem-

perature in 1 minute, or 10 sq in of steel surface to a depth of 0.030in at hardening temperature in 5 to 10 seconds.

The steel cabinet is amply provided with inspection panels incorporating interlock safety switches. Controls are all on the front and the R.F. output is taken from one side, so the generator can be conveniently installed against the wall or in a corner.

The generator is designed to operate from a three-phase three-wire 360/444-volt supply, and H.T. is provided through six GU21 mercury vapour rectifiers. A voltage-stabilized transformer supplies the oscillator valve filaments and a separate transformer gives a 240-V supply for operating contactors and other auxiliaries.

G.E.C. 25-kW radio-frequency heater.

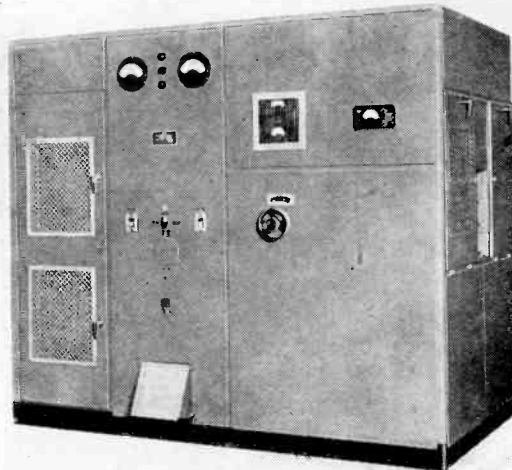

# ASTRONOMICAL RADAR

## Some Future Possibilities

By ARTHUR C. CLARKE

SINCE the early days of radar, suggestions that echoes might be obtained from the moon have often been put forward but were probably not taken very seriously by most people until Sir Edward Appleton in the Thirty-sixth Kelvin Lecture to the Institution of Electrical Engineers' stated categorically that the feat was possible. Its actual accomplishment less than a year later by the United States Signal Corps is typical of the speed of technical progress in these days.

The problems that had to be overcome in carrying out this epoch-making experiment are of considerable interest, and although no full technical report seems to have been published yet, a good deal of general information is now available. The equipment used was a standard Army early-warning set, working on the rather old-fashioned frequency of 111.6 Mc/s. For the experiment a special aerial system was constructed, employing sixty-four dipoles in an eight by eight array. This large aerial was somewhat unwieldy, and apparently incapable of movement in elevation. At any rate the experiments all appear to have been carried out when the moon was on the horizon, and the fact that the greatest possible ionospheric attenuation would then have taken place did not prevent success.

Echoes from terrestrial objects (including aircraft) even at maximum range return to the receiver within a very few milliseconds of the transmitted pulse, and it is possible to use pulse-recurrence frequencies sufficiently high to give an apparently continuous trace on the C.R.T. This means that even if the signal/noise ratio is as low as one to one, the relatively steady echo can be distinguished from the noise appearing

at random along the trace. The "integrating" effect of a long-afterglow tube also increases the discrimination against noise. However, when echoes are being received from the moon the time-lag is multiplied a thousand-fold and the spot on the C.R.T. must take  $2\frac{1}{2}$  seconds to traverse the

the band-width was reduced to the extraordinary figure of fifty cycles. This reduction in the pass-band would give a theoretical improvement in signal/noise ratio of two or three hundred to one over a standard radar set, but must have introduced very great difficulties in connection with receiver and transmitter stability. The Doppler effect due to the earth's rotation would have sufficed to move the signal right out of the receiver pass-band, and adjustments had to be made to allow for this continually changing quantity.

The pulse recurrence frequency used was about twelve a minute, and this combined with the very wide pulse-width of 0.2-0.5 second meant that the transmitter was operating one second in every ten, as compared with about one in every thousand for normal radar. This very greatly reduced the pulse

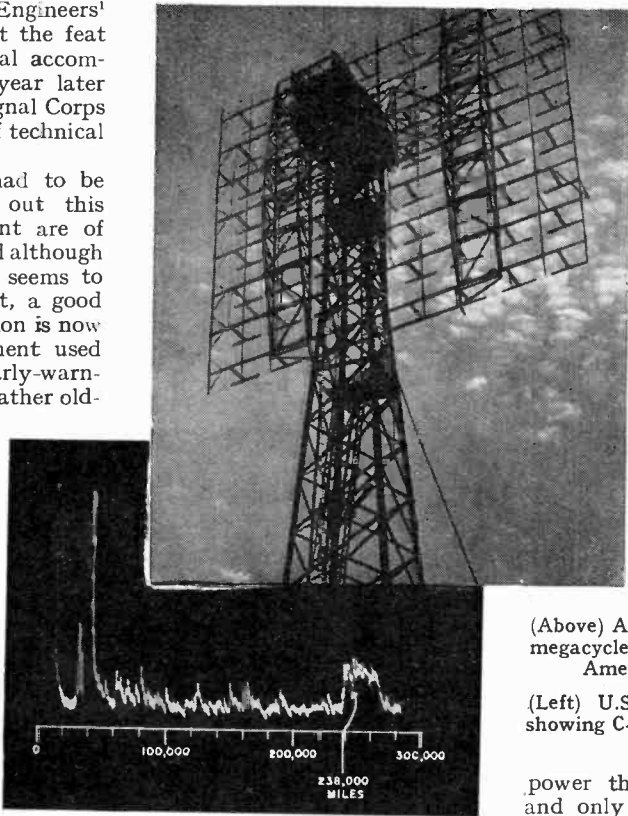

(Above) Aerial system of the 111-megacycle equipment used in the American experiment.

(Left) U.S. Signal Corps photo showing C-R trace of lunar echo.

screen. The picture is no longer continuous, and a fairly high signal/noise ratio is needed for good results.

It is well known that the noise generated in the first stage of a radio receiver is proportional to the square-root of the band-width. As radar pulses have to be a microsecond or less in duration to obtain accurate ranging, band-widths of several megacycles are needed to pass them without distortion. However, in these pioneer experiments extreme range accuracy was not attempted, and

power that could be employed, and only three to five kilowatts peak was actually radiated—a most surprising figure in these days of megawatt valves.

The Signal Corps' experiment was carried out under Lt.-Col. J. H. De Witt at the Evans Signals Laboratories, Belmar, N.J. First contact was made with the moon at 11.58 a.m. on January 10, 1946, only ten minutes after moonrise. (It has also been reported that echoes have been received just before moonrise. This can be easily explained by refraction, which is sufficient at optical frequencies to make the whole moon "visible" to radar when it

### Astronomical Radar—

is actually below the horizon.

The feat is all the more remarkable when one considers that it was achieved by an almost standard Army installation, and it is tempting to consider what might be done with specially designed equipment.

The first obvious step is to move into the microwave region and employ a parabolic array which will throw all the power on to the moon. The moon's angular diameter is half a degree, and the beam-width of the Belmar aerial must have been at least six to eight degrees so that considerably less than one per cent of the modest power transmitted ever reached the target. At a wavelength of ten centimetres, a parabolic mirror smaller than the Camp Evans aerial would have focused almost all the power on the moon and given a ten-fold increase in signal strength.

### Increasing Pulse Power

Although the disadvantages of low pulse-recurrence frequency have been pointed out, if photographic integration of the echoes is used these can be overcome even if there are long gaps between pulses. Since magnetrons are now available with peak outputs of over two megawatts<sup>2</sup>, a tremendous increase in range should be easily obtainable. Using intervals between pulses of a minute or more, the magnetrons could be operated at even greater overloads than normal. Indeed, if planetary ranging is to be attempted "single-shot" working would be inevitable, as the table below shows.

#### Minimum Echo Times.

Moon .. ..	2.56	seconds
Venus .. ..	4.5	minutes
Mars .. ..	6.2	"
Mercury ..	8.8	"
Sun .. ..	16.6	"
Jupiter ..	1 hr. 6 mins.	
Outer Planets	2-10	hours

As the writer has pointed out elsewhere,<sup>3</sup> long-range radar sounding has scientific implications of the greatest importance. The most fundamental measure in astronomy is the distance of the earth from the sun, and hitherto this has been deduced by most elaborate observations spread

over a large portion of the globe, and requiring months of analysis before the results can be extracted. It would not be necessary to receive direct echoes from the sun to measure this distance: if the nearer planets could be ranged this would give the scale of the solar system and the sun's distance could then be calculated without difficulty. At its nearest Venus is some 25,000,000 miles from the earth and has an apparent diameter of over a minute of arc—almost enough to show a disc to the naked eye were it not then lost in the sun's glare.

It can be shown<sup>1</sup> that the transmitter power required to produce a given echo from a spherical body in free space is proportional to the following quantity:—

$$\frac{R^4 \lambda^2}{a^4 r^2 \rho}$$

where  $R$  is the distance of the body,  $r$  its radius,  $\rho$  its reflection coefficient,  $a$  the diameter of the array, and  $\lambda$  the wavelength. Taking the figures for the Belmar experiment ( $R=250,000$ ,  $r=1,000$  miles) and assuming that  $a$  and  $\rho$  are unchanged but that a wavelength of 10 centimetres is used, it is possible to get a rough estimate of the power needed to range the other planets. For Venus at its nearest  $R$  is 25,000,000 miles and  $r$  is nearly 4,000 miles. Hence the peak power needed would be 7,000 times that required for the Belmar experiment, or about 35 megawatts.

This is rather a lot of power, to say the least, but before seeing how we can whittle it down let us consider another example which gives a somewhat surprising result.

### Solar Radar

The sun is 400 times as far away as the moon, but its radius is 400 times as great—by that extraordinary coincidence which makes total eclipses possible. Thus to reach it with 10-centimetre waves we need increase our power by only 180 to a level of 0.9 MW—much less than was needed by Venus at a quarter of the distance. Though these figures are, of course, very rough, they represent maximum values and probably give a fair idea of

the orders of magnitude involved.

A power of 0.9 MW is within present limits, but 35 MW is rather more than we can hope to generate for some time—though seeing what has happened in the last few years it would be unwise to be dogmatic on this point. However, there are two ways of improving the situation, as may be seen from the equation above. If we could triple the size of the array, this would at once bring the power down to less than half a megawatt. A 150-foot mirror would be a considerable piece of engineering, but as it could be laid on the ground and elevated at one end its construction would not present any insuperable difficulties, especially as it could be made of metallized fabric stretched over a suitable framework. With such an array, it would be possible to receive echoes from Mars when powers of 20 MW are available.

### Light-ray Echoes

The second alternative is a decrease in wavelength. It is presumably only a matter of time before the powers now available at 10 centimetres can be obtained at still higher frequencies, but there seem good arguments for moving right down the spectrum into the optical region, at any rate for short-range (!) lunar working. During the war, gas-discharge tubes were developed which gave light pulses of such intensity that aircraft could take night photographs of ground objects. By discharging condensers through such tubes and focusing the light on the moon, it might be possible to make a very simple and efficient pseudo-radar system. The detector would be a photo-multiplier cell with a filter to pass only the light of the—if possible—monochromatic flash. The analogy with a narrow-bandwidth radar system would then be perfect, and when one considers that a 1,000-volt condenser discharging at a rate of 100 amps represents a pulse-power of 100 kW the possibilities are impressive.

The ultimate range and accuracy of "astronomical radar" cannot be easily decided, but an increase of bandwidth to a few

hundred cycles would give range accuracy of a thousand miles, which means an error of only 0.001 per cent in the radius of the earth's orbit. This is a far greater degree of precision than has ever been available before and there is probably little point in increasing it. However, Appleton has made the interesting suggestion that radar might be used to check the heights of the lunar mountains, and this would require megacycle band-widths and the type of trace expansion used in gun-laying radar. It might even be possible, by a careful choice of frequencies, to discover if the moon has an ionosphere—though probably any frequencies which could penetrate our E and F layers would make short work of the moon's defences.

Quite recently the somewhat surprising fact has been revealed that the Federal Telephone and Radio Corporation is now seriously considering the use of the moon as a reflector for radio transmissions when normal S.W. links are broken by severe ionospheric disturbances. Henri Busignies, Technical Director of Federal, has calculated that at the minimum economic band-width (about 500 cycles) something like 100kW (continuous wave) power would be needed to provide a reliable service. Powers of this order can now be generated at frequencies of up to 600Mc/s by tubes of the "resnatron" type.<sup>4</sup> Only low speeds of working could be used on this system, and there would be other practical limitations: for example, the moon must be visible at both stations simultaneously. However, the plan is a very interesting one, perhaps a forerunner of the space-station relay-chain recently described by the writer.<sup>5</sup>

To end, if possible, on a slightly more speculative note, the question asked of the *Wireless World* "Brains Trust" some years ago<sup>6</sup> appears to have been answered in good measure. Interplanetary radio communication is an immensely simpler task than radar contact since only a square law of distance is involved. Even the present Signal Corps equipment gives a field-strength on the moon equivalent to that of a medium-power local station!

When the fuels and motors are

available, Zworykin's suggestion that remotely-controlled rockets carrying televisors be sent round the moon will present no major difficulties from the communications side, whatever other problems may arise. But those hopeful individuals who expect to see radar meteor-detectors for space-ships are certainly doomed to disappointment, since the average meteor is far smaller than a rifle-bullet and travels fifty times as fast. One could scarcely detect such an object—still less determine whether it were on a collision course—more than a fraction of a second before impact, which would be of no practical use whatsoever. Fortunately meteors large enough to be dangerous are excessively rare: as lethal agents they are much less effective than motor cars and similar hazards of everyday life.

It is quite certain that an era is now beginning in which co-operation between radio engineers and astronomers may produce some spectacular and perhaps quite unforeseen results. When one remembers how radar was the child of pure radio research, who would dare to say what the third generation may not bring?

**Addendum.**—Since this article was written, the Bell Telephone Laboratories have announced the development of "metal lenses" which can produce microwave beams down to a *tenth of a degree*

in width. They are constructed of arrays of metal strips mounted in front of a horn radiator about twelve feet across and appear to be much smaller than the equivalent parabolic mirrors.

This important discovery may mean that the high-gain arrays needed for astronomical radar may be nothing like as large as those envisaged—or alternatively much greater ranges may be attainable with the same apertures.

It is also of interest to note that the optical "radar" system proposed above is already in use in the "Cloud Range Meter" (*Wireless Engineer Abstracts*, No. 1943, July, 1946). This device consists of two parabolic mirrors, one with a high-voltage spark at its focus and the other carrying a photoelectric cell. Echoes are displayed as deflections on an A-scope as in normal radar.

Further details of this instrument are given in the *General Electric Review* for April, 1946.

#### References

- <sup>1</sup> Sir Edward Appleton: *Scientific Principles of Radiolocation*; J.I.E.E., Pt. 1, September, 1945.
- <sup>2</sup> *Wireless World*; May, 1946.
- <sup>3</sup> *Journal of the British Astronomical Association*; September, 1945.
- <sup>4</sup> *Waves and Electrons*; April, 1946 (p. 169).
- <sup>5</sup> *Wireless World*; October, 1945.
- <sup>6</sup> *Wireless World*; November, 1942.

## SENSITIVE VALVE VOLTMETER

WITH an input impedance of 2 MΩ and a frequency range of 50 c/s to 250 kc/s the Type 378A

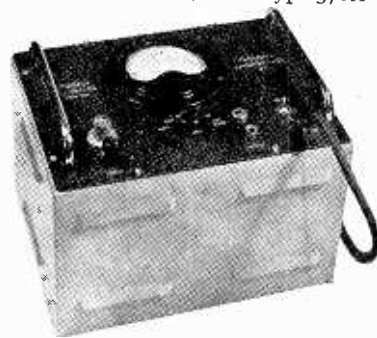

Type 378A feedback valve voltmeter.

valve voltmeter made by Furzehill Laboratories, Ltd., Boreham Wood, Herts, is capable of measuring voltages from 1 mV to 100 V in five ranges.

The indicating circuit comprises a diode bridge rectifier feeding a 0.5 mA meter with shaded pole pieces designed to give an open scale for the lower readings and constant percentage reading accuracy at any part of the scale. The input valve is a cathode-coupled triode and is followed by two pentode amplifiers with negative feedback giving a gain of about 2,000, which is substantially independent of mains fluctuations and ageing of valves. A jack is provided so that the amplifier can be used separately if desired. The price of the instrument is £75.

# H.M.S. "BOXER"

## The Navy's First All-Radio Ship : Her Main Armament is Radio

By G. M. BENNETT

**A** START was made with the installation of fighter direction equipment—gear for the direction of our own aircraft onto enemy aircraft—in ships of the Royal Navy in 1941, when aircraft carriers were given priority and fitted on the largest scale. Subsequently the necessary equipment was also fitted in battleships and cruisers, though on a smaller scale than in the carriers, for only the latter would be required to direct regularly a large number of aircraft operating from their own decks. Warships were fitted for fighter direction primarily that they might control the fighters of their own Air Arm operating from carriers. But they could equally well direct R.A.F. fighters when these were providing cover for destroyers and smaller craft, and convoys escorted

---

Receiving portion of a naval long-range aircraft warning radar set as fitted in H.M.S. *Boxer*. The units nearest the camera are the associated I.F.F. interrogator. The receiver including two A-scan tubes is next with duplicate P.P.I.'s on the extreme left.

---

by them. It is, however, difficult to provide fighter direction facilities in the smaller warships without sacrificing part, if not all, their armament, which is clearly unacceptable if they are to retain their normal status. There is insufficient space to accommodate the necessary gear and, moreover, the top-weight considerations will

not permit the requisite radar aerials to be mounted.

The solution to this problem was the provision of special Fighter Direction Ships—converted small merchant ships. These could carry a heavy anti-aircraft armament and fighter direction equipment on a scale comparable with that in an aircraft carrier. They, however, had a number of limitations, of which the chief lay in the inadequate cover provided by the naval radar sets against low-flying aircraft and, to a lesser extent, aircraft flying over the land,

not provide it for the troops on the beaches—a joint Navy-R.A.F. responsibility in the early stages.

Perhaps this was not altogether surprising since the Navy's radar sets had been designed for operation in ships at sea. The R.A.F. radar sets, designed for use ashore, did not, however, suffer to the same degree from these operational limitations. The installation of R.A.F. sets in ships was at once considered, but R.A.F. designers had not had to bear in mind the weight and space considerations inherent in ship installations. The Navy and R.A.F., working in co-operation, found a practical solution. They installed a combination of Naval and R.A.F. equipment in a Landing Ship Tank (Mark 2) and thus converted it into a Fighter Direction Tender. Her rôle in an amphibious landing was to operate close to the beaches in conjunction with the fighter direction ships. Together they were able to control all the fighters provided, first by the Navy and later by the R.A.F., both over the ships off the beaches and over the beaches themselves until the R.A.F. established landing grounds and their own fighter direction organization ashore. They were thus used in the landings at Sicily, Salerno and Normandy. As a result of the experience gained during these operations it was decided to provide a fighter direction ship capable of fully carrying out her functions without the aid of an auxiliary tender. Again the Navy and the R.A.F. pooled their respective knowledge of fighter direction from the sea and land aspects. And H.M.S. *Boxer* was born.

She was one of three Landing Ships Tank (Mark I) laid down in March, 1943. The *Boxer* herself was under construction at the yard of Messrs. Harland & Wolff, at Belfast. She was a vessel of 5,650 tons displacement, 450 ft in length with a speed of 16 knots. She was converted before comple-

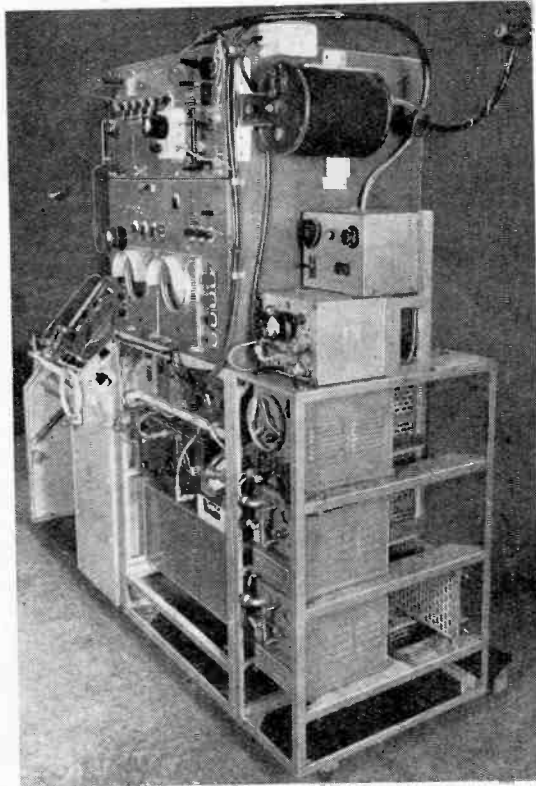

when it was difficult to distinguish their echoes from those of hills. These limitations not only made it impracticable for the Navy to provide effective fighter protection for ships lying off shore, but in amphibious operations they could



**H.M.S. Boxer—**

communicate with both R.A.F. and military ground stations when established ashore after the assault on the beaches has been successful. All this is in addition to communicating with fighter aircraft on a number of different V.H.F. channels and with other ships which may at one time or another be required to direct fighters; with ship and shore radar installations and with aircraft carriers and airfields ashore from which fighters are provided.

The majority of the radio equipment is subdivided between three transmitter rooms and two receiving rooms, though some of the smaller sets are fitted in other compartments for specific purposes. The R/T transmitter used on the Fleet's manœuvring wave, a self-explanatory description, is operated from the bridge, whilst all the V.H.F. sets and a considerable number of the others, are remotely controlled from the Control Room.

Other wireless equipment includes a V.H.F. direction finder with "crossed H" balanced Adcock aerials and remote receiver with goniometer for the aural detection and direction-finding of enemy R/T transmissions. This is used as a complementary aid to radar in obtaining information about the movements of enemy aircraft. There is also a V.H.F. radio direction-finder operating on the same principle as the above, for taking bearings of our own fighters' R/T and thus for homing them to base when they have temporarily lost their bearings. Again this is complementary to the facilities provided by radar. There is a radio direction-finder operating in the 60 to 1,000 kc/s band, used by the ship as a navigational aid.

There is also a W/T beacon, a device whereby aircraft can home themselves on to the Fighter Direction Ship when uncertain of their position. This consists of a transmitter with a continuously rotating directional aerial, which sends out a different combination of morse letters in each of a number of arcs of the compass. It is connected with the ship's gyro compass in such a way that these arcs always bear the same rela-

tionship to true north, whatever the direction of the ship's head. Aircraft tuning to this beacon can, according to the combination of morse letters which they receive, rapidly determine, within a few degrees, the direction of the ship of origin.

**OUR COVER**

*This month's cover illustration gives some idea of the multiplicity of aerials carried by H.M.S. "Boxer" for her complex radio and radar equipment. The domed structure forward is a protective housing for some of the aircraft-direction radar equipment.*

The installation of all this radio equipment introduced numerous difficult problems similar to those encountered with the radar sets. That it was made possible to operate so much radio equipment within such a relatively small space, without prohibitive mutual interference between sets, speaks volumes for the ingenuity of the designers; in fact an article might well be written on the problems involved, and solved.

**Collating the Data**

Finally, there is the Control Room, the nerve centre of the ship. This is divided into two parts, the Filter Room and the Aircraft Direction Room. The information obtained by all the ship's radar sets is conveyed to the Filter Room by remote display equipments, these, in the majority of cases, being P.P.I.s. Other information—W/T and R/T reports from other ships and from shore stations, and bearings obtained by the D.F. sets—is also conveyed to this room either by remote control of the equipment concerned or by telephone. All this information is plotted and filtered in order to give a clear picture of the situation in the air within the zone in which the ship is operating. This filtered picture is broadcast by R/T for the information of ships in company and passed to the Aircraft Direc-

tion Room, where the Senior Fighter Direction Officer makes tactical use of it, to display to the best advantage all the fighters at his disposal. The actual control of these aircraft is undertaken by a number of assistant F.D.O.s each of whom has his own plot on to which such information as he needs is transferred from the main plot. Each assistant F.D.O. is provided with the means of remotely controlling the R.T. equipment required for his purpose.

In conclusion it is of interest to note that out of a total complement of approximately 500 officers and men, the *Boxer* carries some 30 officers and 250 men whose duties are concerned with the operation and maintenance of her vast and complicated radio equipment.

**FREE CONE SUSPENSION**

A NEW 10-inch loudspeaker (Type W.10/C.S.) has been introduced by Wharfedale Wireless Works, Bradford Road, Idle, Yorks. It is of the P.M. type with an Alcomax II magnet giving 14,000 lines per square centimetre in a gap



Wharfedale W.10/C.S. permanent magnet loudspeaker.

1 inch in diameter and  $\frac{1}{4}$  inch deep. The chassis is a die casting and the cone is suspended by an external centring spider and a soft cloth surround at the periphery. Speech coil impedances of 2-3 chms or 12-15 ohms can be supplied and the power loading capacity is 7 to 8 watts. The price is £7.

**H.M.S. Boxer—**

tion to the Navy's new conception of a fighter direction ship and rejoiced on commissioning in the official title of Landing Ship Fighter Direction. Rather than attempt to describe the ship's appearance, I will refer the reader to the illustrations of H.M.S. *Boxer* on the front cover and on this page. The vast amount of radio equip-

The rectangular array on the after-deck of H.M.S. *Boxer* forms part of the ship's aircraft direction equipment. The half-cheese aerial amidships is for the W/T beacon. V.H.F. transmitting dipoles are carried on the yard arms on each of the ship's four masts.

ment took up so much space, whilst the many aerials required no less than four masts and much of the deck space to carry them, that there was left room for only a close-range armament of light weapons. This vessel can, therefore, be truthfully described as the Navy's first all radio ship: her main "armament" is radio.

The *Boxer* was commissioned shortly after V.E.-Day, and after undergoing trials sailed for the Far East. In all probability her first major operation would have been the recapture of Singapore. But V.J.-Day arrived when she had steamed only as far as the Mediterranean.

So much for the gestation and birth of the ship. Now for her radio installation in some detail.

**Radar Gear**

There are, in the first place, no less than six high-power radar sets. The installation of so many large equipments in a single ship involved the solution of many difficult problems ranging from

finding accommodation for apparatus and large heavy aerials to the eradication of mutual interference between individual sets. It may be questioned why so many were needed. Operationally, separate sets for use against aircraft and surface vessels are neces-

sary, are normally in the quiescent receiving state but, when triggered by an aircraft's radar set, they transmit a signal which is received by the aircraft and is used as a homing aid.

With each radar set is an associated interrogator for triggering

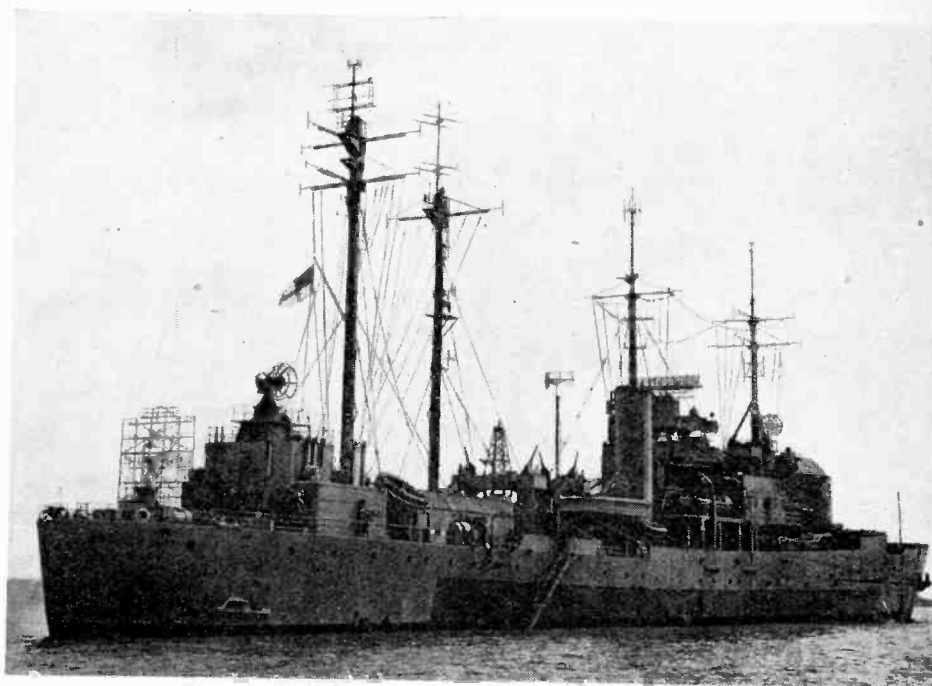

sary and the ship herself requires the latter both for her own protection and for navigation. Technically it is impracticable to design a set which will give long-range warning of high-flying aircraft a hundred miles away and also detect the approach of low-flying planes. There are limits to the number of planes which can be effectively tracked with a single radar set. Equipment specifically designed to measure the heights of approaching machines is necessary in addition to those giving range and bearing. And, of course, standby sets are necessary to guard against breakdown and action damage.

All the radar transmitters and their associated receivers are accommodated in a number of different offices about the ship, largely in the superstructure.

Additional radar equipment includes radar beacons. These small transceivers, working on the same band as aircraft radar

the I.F.F. equipment fitted in our own aircraft and ships. Finally, the ship herself carries an I.F.F. set to be triggered by our own warships and aircraft when they detect her with their warning radar equipment.

**Communications Equipment**

Turning to communications equipment, the ship needs a large number of different transmitters and receivers, some using R/T, some W/T, working on the various frequencies used both by the Navy and by the other two Services, particularly the R.A.F., during amphibious operations. She must be capable of transmitting messages on frequencies between 4 and 20 megacycles hundreds of miles back to a distant base. She must work with various types of warship, landing craft and merchant ships in company for which frequencies in the M.F., H.F. and V.H.F. bands are all used. She must be able to

# NOISE AND PULSE MODULATION

## Theoretical Possibilities and Practical Realization

By THOMAS RODDAM

**P**ULSE modulation for communication circuits is likely to become as fashionable as frequency modulation. The basic principles of pulse modulation systems have already been described in *Wireless World*<sup>1</sup> and details of the Army Set Number 10 and of American equivalents

pulse working do not lend themselves to amplitude modulation: the block magnetron, for example, is very much a fixed level device and is liable to mode changes if the level is altered. Pulse width modulation and pulse

can be obtained. Fig. 1 shows how pulse position modulation is effected. In the absence of a modulation signal a train of equally spaced pulses is emitted: these pulses are displaced by the modulation signal by an amount proportional to the amplitude of the modulation. There is a slight ambiguity to be watched: the displacement of the pulse may be proportional to the amplitude at the *undisplaced* epoch, or it may depend on the amplitude at the *displaced* epoch. The difference is only important when the modulation frequency is approaching the same order as the pulse repetition frequency: at low modulation frequencies the difference is obviously trivial.

Methods of producing pulse position modulation are outside the scope of this article. We do, however, need to know how the intelligence is extracted at the receiver. The simplest way is to convert the pulse position modulation into pulse width modulation by generating a new pulse, the leading edge of which is produced by the leading edge of the incoming signal pulse, but having the trailing edge produced at a fixed reference phase which may either

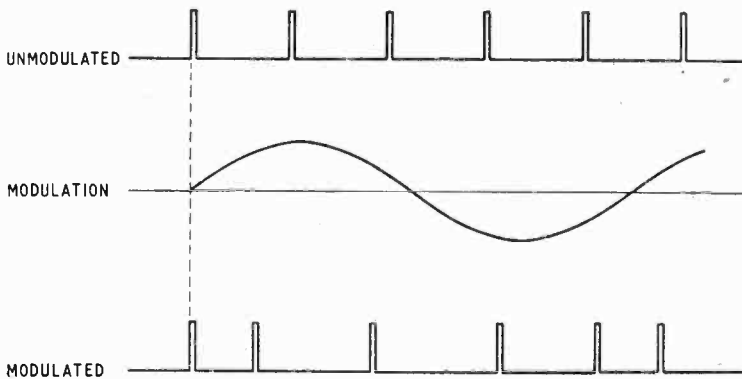

Fig. 1. Pulse position modulation.

have been published. For high fidelity at very high frequencies pulse modulation offers some advantage over frequency modulation: the pulse circuits are relatively simple switching circuits, whereas with F.M. careful design of the phase characteristics is required.

There are, of course, several different systems of pulse modulation. If efficiency and convenience are the criteria, it is not difficult to eliminate some of these systems for practical use. Pulse amplitude modulation, like ordinary amplitude modulation, requires that the mean power level of the transmitter should be kept down to enable 100 per cent modulation to be reached. Most of the energy is used in the "carrier" and relatively little in the "sidebands."<sup>2</sup> Furthermore, many of the transmitter circuits which have been designed for

frequency modulation also involve some loss of efficiency in order to meet the demands of 100 per cent modulation.

Pulse phase modulation, or pulse position modulation as it is alternatively called, has the very great advantage that both the amplitude of the pulses and the

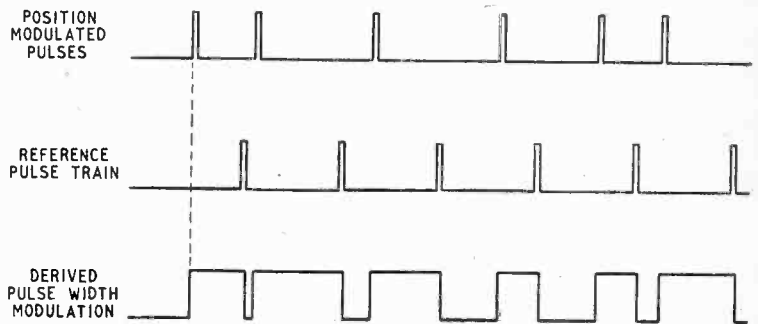

Fig. 2. Reception of pulse position modulation.

number of pulses per second are constant, whatever the modulation. In consequence, the operating conditions of the transmitter are such that high efficiency

be derived from a transmitted marker pulse, or alternatively may be generated by an oscillator in the receiver. The process is shown in Fig. 2. If this width

<sup>1</sup> April, 1946.

<sup>2</sup> This is not strictly true; by sidebands we must understand the sideband components corresponding to the signal.

**Noise and Pulse Modulation**—modulated signal is passed through a low-pass filter, the output contains only the modulation. It is necessary that the filter should cut off at the highest modulation frequency, and that the pulse repetition frequency should be about three times this. Again, the reasons for this are outside the scope of this article, but it is necessary to know how the

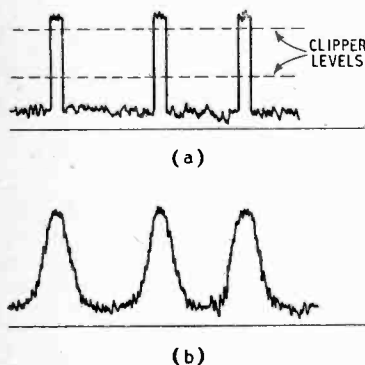

Fig. 3. (a) Idealized signal in presence of noise. (b) Real signal in presence of noise.

modulation is extracted before we can determine how the system responds to noise.

In Fig. 3 (a) the signal of Fig. 1 is shown with the addition of noise, and on a larger scale. The two dotted lines marked "clipper levels" show the operating thresholds of limiter circuits which precede the trigger circuits producing the width-modulated pulses. Obviously, so long as the received signal is sufficiently above noise level for the limiters to operate in the way shown, noise has no effect on the circuit at all. At last a noise-free communication system has been devised.

Unfortunately this just isn't true: the reader has been quietly led up the garden by a rather special form of false simplification. If we consider what is wrong with Fig. 3 (a) we shall be able to construct a correct picture, and from it determine what the signal to noise ratio really is. The first thing to notice is the *shape* of the pulses in Fig. 3 (a). As drawn they are absolutely square: they rise in less than one-hundredth of their length. Now let us think

of a number. A reasonably good speech circuit will transmit frequencies up to 5,000 c/s; C.C.I.R. requirements for broadcasting circuits are 10,000 c/s; a telephone circuit incorporating a simple privacy system cuts off just below 3,000 c/s. We need about three pulses to define a single cycle of the highest modulation frequency, so that each channel requires a pulse repetition rate of 10,000 pulses per second at least, or up to 30,000 pulses per second for broadcasting quality. If now we multiplex five of the lowest quality channels (and the Army Number 10 set has eight channels), the pulse repetition rate is 50,000 pulses per second. The spacing between pulses is therefore 20 microseconds and the length of each pulse must only be one or two microseconds. In our diagram, therefore, the pulse rises to full amplitude in less than one-hundredth of a microsecond and the band-width of the circuit is therefore several hundred megacycles! The noise, however, is "ordinary band-width" noise, and we have deceived ourselves by the device of using a wider band for the signal than for the noise.

In Fig. 3 (b) the received signal has been redrawn as it really is. The band-width has been made just adequate for the length of the pulses, so that the leading edge has quite a definite slope. On top of the pulse itself, noise can be seen riding, so that the exact position of the leading edge, when viewed on an oscilloscope is "fuzzy" and uncertain. This uncertainty in position is the key to the analysis of noise in pulse modulation systems, just as the uncertainty in amplitude produced by noise is the key in amplitude-modulated systems.

If the pulses of our communication system were displayed on a cathode-ray tube in such a way that they were all superimposed—which is just how we should display them with a triggered time-base to examine the pulse shape—the picture would look rather like Fig. 4. The fuzz due to random noise, of amplitude  $N$ , shows clearly on top of the signal of amplitude  $S$ . The noise is shaded with vertical lines to indicate that at any point the *vertical* height of

the fuzz is constant and equal to  $N$ .

If we are using a receiver of band-width  $2F$  (corresponding to a video band-width of 0 to  $F$  c/s), the circuit build-up time is equal to  $1/3F$ . The rate of rise of the steep part of the leading edge is therefore equal to  $S/3F$  volts/second. The horizontal distance  $x$  shown in Fig. 4, which is the uncertainty in position of the pulse front at the level chosen, is equal to  $(N/S)(1/3F)$  seconds. This is a sort of noise magnitude in time, which replaces the noise magnitude in amplitude, and it is actually produced by the process of reception, although it is independent of the exact mechanism of reception.

Modulation of the pulse is effected by moving it bodily, and we may assume that the amount of position change for 100 per cent modulation is  $D$  seconds. The noise term calculated above therefore corresponds to  $(N/S)(1/3F)(1/D)$  per cent modulation so that the output signal/noise ratio is  $(3DF)(S/N)$ . If we had used amplitude modulation, the signal/noise ratio would have been simply  $(S/N)$ ; thus the use of pulse position modulation has introduced a factor  $3DF$ . To get an improvement in signal/noise ratio this factor must be greater than unity. We shall now consider how this factor is determined.

Let us assume that the highest modulation frequency to be transmitted is  $f$  cycles/second and that

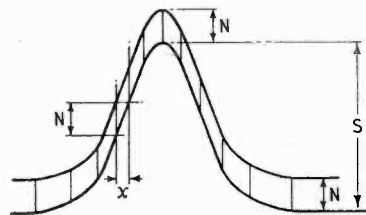

Fig. 4. Typical pulse, with noise.

$n$  channels are to be transmitted in multiplex. One of these channels may be used only as a marker channel, so that the reference train of pulses shown in Fig. 2 need not be separately generated in the receiver. Alternatively, if a more complex receiver is used, the reference train can be internally generated, thus providing an extra signal channel. Each chan-

**Noise and Pulse Modulation—**nel requires the transmission of  $3f$  pulses per second, so that the whole system uses a repetition rate of  $3nf$  pulses per second. The time between successive unmodulated pulses is therefore  $1/3nf$  seconds. Whatever happens, the pulses of one channel must not be modulated into the region which may be occupied by pulses of another channel. The way in which this is arranged can be seen in Fig. 5, from which it is clear that the pulses are never modulated into the time reserved for another channel. The length of the guard time cannot easily be made less than about  $3/2$  times the pulse length, and the pulse length, as we have already seen, is about  $2/3F$ , where  $2F$  is the band-width. The guard time is therefore about  $1/F$ .

Thus we have a space of  $1/3nf$  seconds between pulses, of which we need  $2/3F$  for the pulse itself and  $1/F$  for guard time. This leaves  $(1/3nf - 5/3F)$  for the displacement  $D$ . We have already seen that the noise improvement factor is  $3DF$ , so that the actual value of this factor for any system becomes  $F/nf - 5/3$ .

Provided that  $F/nf$  is greater than  $2\frac{2}{3}$ , the use of pulse position modulation leads to an improvement in signal/noise ratio.

As an example, let us take  $f = 10$  kc/s,  $n = 1$  and  $F = 75$  kc/s. The improvement factor then becomes  $(7.5 - 1.67) = 5.83$ , corresponding to an improvement of nearly 14 decibels over the amplitude-modulated case. If we take  $f = 3$  kc/s,  $n = 8$  and  $F = 1$  Mc/s, which represents a typical pulse communications multiplex system, the improvement factor is about 32 decibels.

This treatment of noise assumes, as is usual, that the noise is "uniform" noise. Impulsive noise, which is produced by ignition systems, for example, is more troublesome in towns. If the level of the impulsive noise is not too high, the limiters used in pulse modulation receivers will eliminate it except when a pulse of noise coincides with a signal pulse. This will happen infrequently. If the noise is too great, a pulse of noise will produce false triggering of the width-modulated pulse generator in the receiver provided that the false pulse arrives during the

active period (i.e., not in the guard time) and *before* the signal pulse. Furthermore, only the time of arrival has any effect on the amplitude of the noise output, so that the impulsive noise is automatically limited to driving

whether we are getting any real improvement. If we make  $F = (8/3)nf$  we get exactly the same signal/noise ratio as for amplitude modulation. Each pulse lasts for  $2/3F$ , so that the total mark/space time ratio at the transmitter

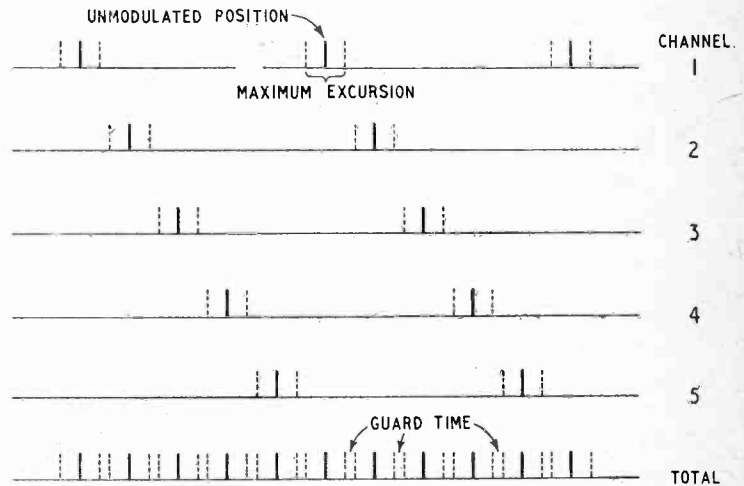

Fig. 5. Interlacing of pulses in a five-channel multiplex system, showing guard time between positions of maximum excursions.

the wave up to 100 per cent modulation. If, at the instant the noise pulse arrives, the audio modulation is 90 per cent, and the pulse arrives just at the worst moment, the apparent noise modulation will only be 10 per cent. There is thus a very considerable improvement in protection against impulsive modulation.

From the above discussion it is clear that pulse modulation can give a considerable gain in signal to noise ratio. Let us now see

is  $2nf/3F$ , which equals  $\frac{1}{3}$ . Consequently a transmitter using pulse position modulation will give the same signal/noise ratio as one using amplitude modulation, but the mean power required is only one-quarter. There is thus a very real power saving. The price paid is in band-width. Ideally  $n$  channels, each sending frequencies up to  $f$  c/s, need only a total band-width of  $2nf$ . We are using  $5\frac{1}{3}nf$ , nearly three times the band-width, to transmit the same amount of information by means of pulse modulation. At very short wavelengths, in the centimetre band, it does not seem as though there will be any difficulty about using very wide bands for fixed station communication systems: in any event with present techniques, tuning and stability difficulties make narrow band systems impracticable. Pulse modulation may well be the most convenient system for a long time to come, so that we may see a really functional arrangement of modulation methods: single side-band amplitude modulation at medium and high frequencies; frequency modulation between 30 centimetres and 3 metres; and pulse modulation only for the shorter wavelengths still.

A.C./D.C. TRANSPORTABLE

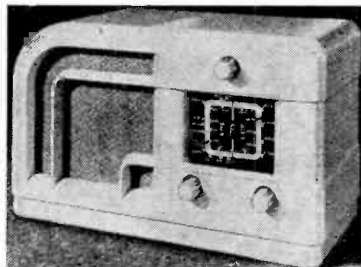

This compact two-band "universal" superhet has just been introduced by Ferranti. A plate aerial is fitted inside the moulded cabinet. Price is £13, plus £2 15s. 7d. purchase tax.

**TEST REPORT**

**R.G.D. MODEL 1046G**

**T**HE first post-war R.G.D. radio-gramophone maintains the high standard of workmanship and performance which this firm set for itself in the years before the war. The quality and finish of the cabinet work are in no way inferior to pre-war products and the chassis construction reflects the experience gained in producing radio apparatus for the Services; both cabinet and chassis are designed to "tropical" standards.

The automatic record changer unit includes a lightweight moving iron pick-up of new design incorporating a permanent sapphire needle point.

**Circuit.**—An R.F. stage precedes the frequency changer on all five waveranges. Each section of the tuning condenser is divided and on the three short-wave ranges the capacity is reduced to about 100  $\mu\mu\text{F}$ , giving a degree of bandsread tuning.

There is one stage of I.F. amplification in which two degrees of selectivity are obtained by switching an auxiliary coup-

ling winding on the input I.F. transformer. For high-fidelity reproduction from local stations the bandwidth is increased by introducing series resistances into the aerial and R.F. coupling circuits.

Signal rectification and the pro-

takes the output from the radio section. This is followed by a resistance-coupled phase splitter feeding two PP<sub>3</sub>/250 valves in push-pull, designed to give a maximum output of 8 watts with less than 3 per cent distortion.

Separate tapings on the output transformer enable external speakers of 2- or 15-ohm impedances to be connected, and a switch is provided on the control board to cut out the internal loudspeaker when desired.

**Performance.**—

Quality of reproduction is always one of the first matters of interest in any new R.G.D. set. In the past the makers have made full use of de-

velopments such as twin speakers, acoustic labyrinths and the like, to improve quality; yet in the present model with its single loudspeaker unit we think the reproduction is as good as if not better

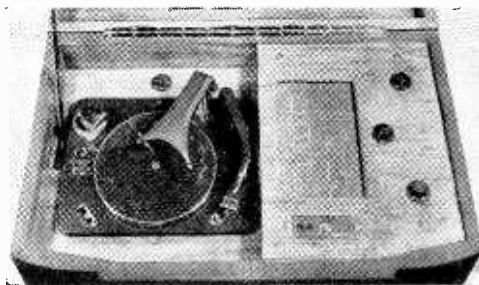

General view of control board. A lightweight moving iron pick-up of new design is a feature of the automatic record changer.

vision of A.V.C. are taken care of by the diodes of a double-diode-triode. The triode section is used solely as an extra A.F. stage after the gramophone pick-up and a separate pentode valve

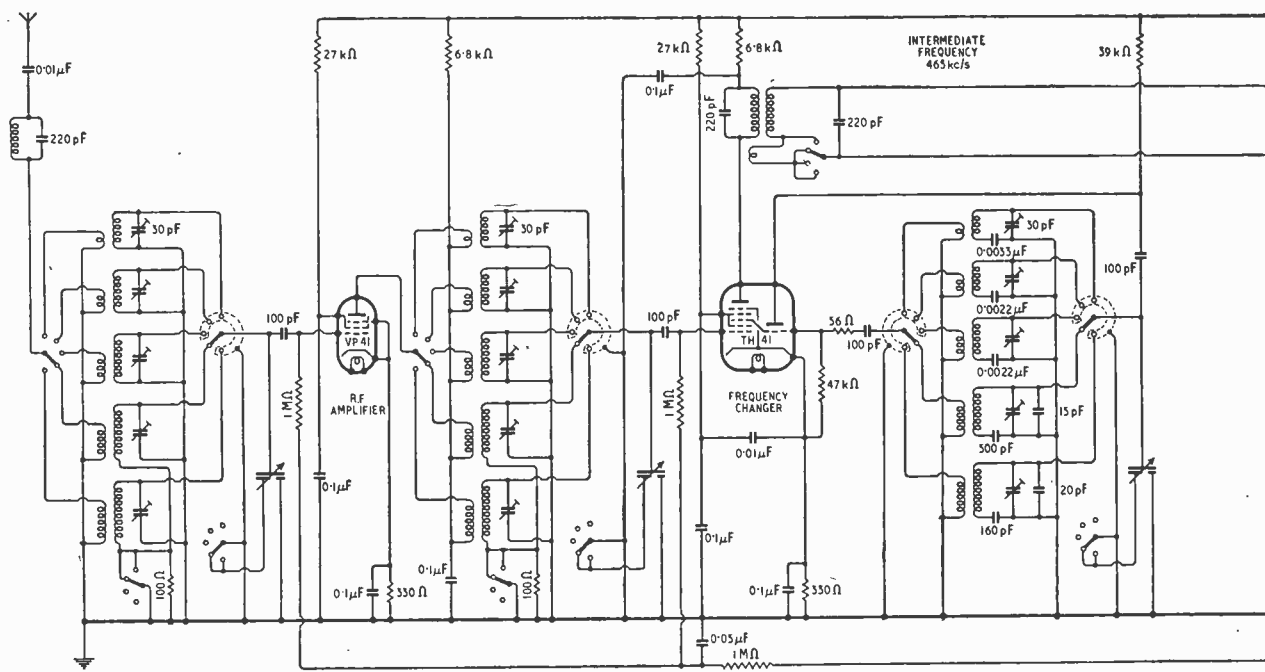

# Radio-Gramophone for A.C. Mains

(Eight Valves + Rectifier and Tuning Indicator)

than anything the company has achieved. The response is crisp and taut and there is no trace of tonal coloration by flabby diaphragm resonances in the bass.

The new lightweight pick-up is a notable advance and reveals impartially the excellence or otherwise of the recordings it is called upon to play. It will treat the record groove walls kindly and we would not hesitate to entrust it with our most cherished records.

In general the radio performance has the refinement one has a right to expect from an instrument in this price category. Signal-to-noise ratio is high on the short- and medium-wave bands and not a single self-generated whistle was to be found on any waveband. Sensitivity on the long waves was adequate for the few stations available, but the background noise was higher than on the other ranges. The three degrees of selectivity have been well chosen and provide the means of extracting the maximum programme value from all types of

### WAVERANGES

Short :  
 13.8-22 m.  
 21-33 m.  
 31-52 m.

Medium :  
 200-550 m.

Long :  
 750-2000 m.

Price : £148 1s.  
 plus £31 13s. 4d.  
 tax.

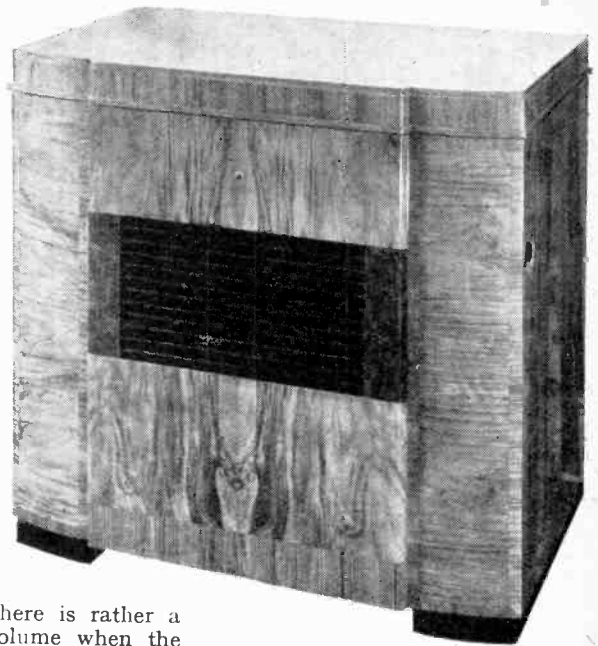

transmission. There is rather a large drop in volume when the selectivity control is switched to the wide-band position and manual re-setting of the volume control is usually necessary; this is a recurring adjustment which the user might reasonably expect to be made automatically for him by some small extension of the "circuitry."

Another detail criticism concerns the tuning control knob. This is of the same deeply fluted variety as those used for the switch mechanisms. A smoother and possibly large knob would be better suited to the lighter and more continuous action of tuning adjustment.

**Constructional Details.** — The cabinet is well braced and is of exceptionally heavy construction; it is free from panel resonance even at the highest volume levels. The weight of the lid is counterbalanced by a spring tensioning device. The record changer motor board is mounted on a spring suspension to eliminate acoustic feedback.

Complete circuit diagram. A split-rotor gang tuning condenser is employed to give band-spread tuning on the short-wave ranges.

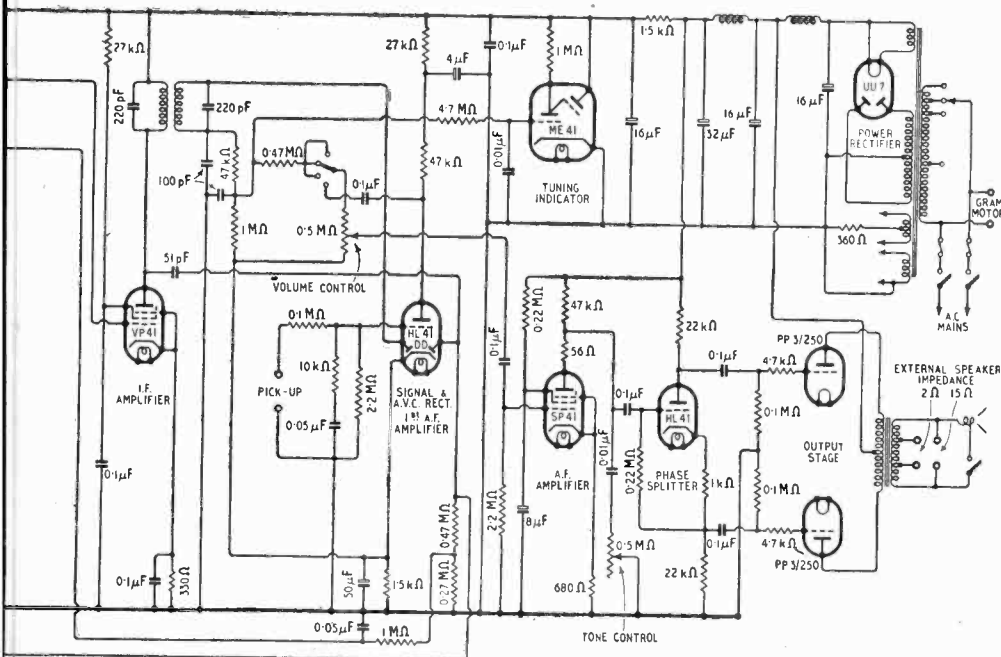

**R. G. D. Model 10466—**

A maximum playing time of 32 minutes is provided by a full loading of eight records; these may be 10- or 12-inch mixed in any order. A pilot light in a corner of the gramophone compartment facilitates record loading and also indicates through a small window in the front of the cabinet, that the set is switched on.

The heavy power supply and audio amplifier components are contained in a separate chassis mounted on the floor of the cabinet, while the R.F. chassis is mounted on its side below the horizontal control panel. The trimmers are all readily accessible from the back of the set and the "underside" of the chassis can be inspected by removing a section of the side panel of the cabinet. A complete circuit diagram is pasted on the inside of this panel.

The R.F. chassis is further subdivided into units and the I.F. section, R.F. unit or 5-range coil unit and switch can be removed separately for test or servicing. The gang condenser has split rotor sections mounted on a ceramic shaft. Both the gang condenser and the R.F. chassis as a whole are supported on bonded rubber mountings.

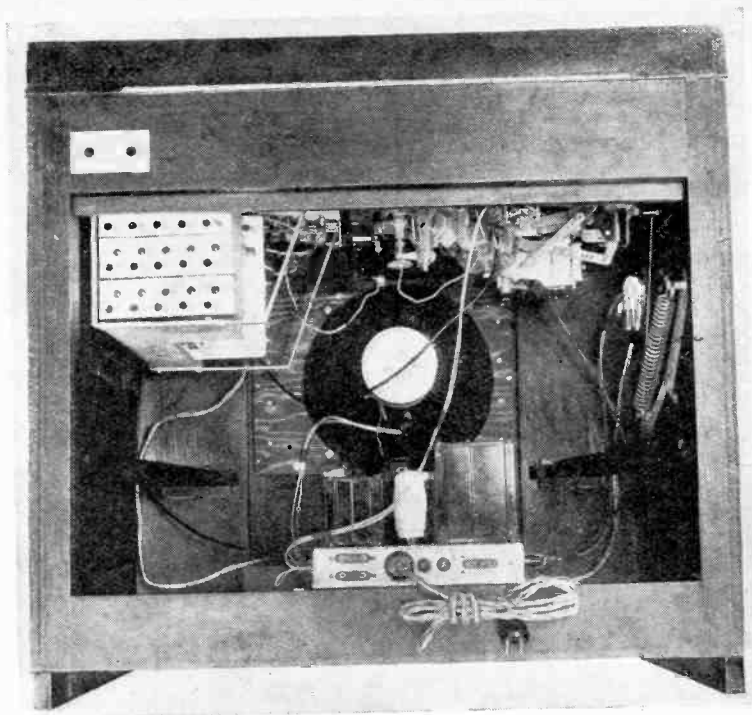

Rear view of cabinet showing separate R.F. and amplifier chassis. The R.F. circuit trimmers are readily accessible.

**Makers.** — Radio Gramophone Development Co. Ltd., Pale Meadow Print Works, Bridgnorth, Shropshire.

casting, television, facsimile and F.M., the book includes directories of U.S., Canadian and South American stations. Pp. 580 (12in x 9in). Broadcasting Publications Inc., 870, National Press Building, Washington, 4, D.C.

## BOOKS RECEIVED

**Heaviside's Electric Circuit Theory.**—By H. J. Josephs. This monograph is based on an "out-of-hours" course of lectures delivered by the author to engineers at the Post Office Research Station, where he is a senior physicist. The author has employed what he calls "Heaviside's Last Theorem" on which to base his electric circuit theory. Pp. 115+viii, with 15 diagrams. Methuen and Co., Ltd., 36, Essex Street, London, W.C.2. Price 4s 6d.

**Understanding Microwaves.**—By Victor J. Young. The material incorporated in this book has been chosen, the author states, with a view to aiding those who have not considered radio waves shorter than 10 centimetres. In an endeavour to make the book understandable by those unversed in mathematics, formulæ have, wherever possible, been relegated to the brief appendices to each chapter. The headings of the eleven chapters are:—The Ultra-High Frequency Concept; Stationary Charge and Its Field; Magnetostatics; Alternating Current and Lumped Constants; Transmission Lines; Poynting's Vector and Maxwell's

Equations; Waveguides; Resonant Cavities; Antennas; Microwave Oscillators; Radar and Communication. A concluding section is entitled Microwave Terms, Ideas and Theorems. Pp. 385+xi, with 172 diagrams. John F. Rider Publisher, Inc., 404, Fourth Avenue, New York 16, U.S.A. Price \$6.00.

**4,000 Years of Television.**—By R. W. Hubbell. Originally published in the U.S.A., this book has now been edited by C. L. Boltz for publication in this country. It gives a popular outline of man's efforts throughout the centuries to improve the means of communicating ideas, culminating in the most complete method of communication—television. 191 pp. George G. Harrap and Co., 182, High Holborn, London, W.C.1. Price 7s 6d.

**"Broadcasting" Year Book, 1946.**—This reference book, prepared by the editorial staff of the Washington weekly journal *Broadcasting* might well be termed the *vade mecum* of American broadcasters. In addition to the F.C.C. rules and regulations on broad-

**Questions and Answers on Electric Lighting and Wiring.**—By E. Molloy. This little book by the editor of *Electrical Engineer*, in the series of Newnes "Q and A" Manuals, covers the theoretical and practical aspects of electrical installation work. Pp. 144, with 87 diagrams. George Newnes, Ltd., Tower House, Southampton Street, London, W.C.2. Price 5s.

**Whittaker's Electrical Engineer's Pocket Book.**—Edited by R. E. Neale, B.Sc. (Hons. (Lond.)). The seventh edition of this well-known Pocket Book has been almost completely re-written to bring it in line with current practice. It contains a vast amount of practical information and data both for the student and practising electrical and radio engineer. Pp. 938+x. Sir Isaac Pitman and Sons, Ltd., Parker Street, Kingsway, London, W.C.2. Price 30s.

**The Thin Red Lines.**—By Charles Graves. The story of the maintenance by Cable and Wireless of a considerable portion of the Empire's lines of communication during the war is told in this book, which records that the company operated 138 wireless circuits (increased from 91 during the war) and 155,000 of the world's 350,000 miles of cable. Pp. 183, with 34 illustrations. Standard Art Book Co., 10, Great Queen Street, London, W.C.2. Price 5s.



**Design Data (8)**

# VIDEO AMPLIFIER H.F. RESPONSE

## II.—Series Correction

**T**HIS form of corrector has the appearance of a low-pass filter section terminated at one end. The performance is similar to that of the Shunt-Corrector, but it has the advantage that it is possible to obtain high rejection of one frequency well above the normal working range. This can be done by placing capacitance in parallel with L of Fig. 1 and the circuit is thus useful in the filter after a detector.

The main practical drawback to the circuit is that for optimum performance it requires the two capacitances  $C_1$  and  $C_2$  to have a definite ratio and it is sometimes inconvenient or impossible to arrange this.

**Assumptions**

That the anode A.C. resistance of the valve is very large compared with R, and that the resistance and self-capacitance of L are small enough to be ignored over the range of frequencies considered.

**Conditions**

The formulae are derived for the condition of flattest frequency response, curves A, and for critical damping, curves B.

**Symbols**

- $E_o$  = output voltage
- $e_{in}$  = input voltage
- A =  $E_o/e_{in}$  = amplification
- $g_m$  = mutual conductance of valve
- R = coupling resistance
- L = correction inductance
- $C_1$  = total capacitance on input side of L
- $C_2$  = total capacitance on output side of L
- C =  $C_1 + C_2$
- f = maximum frequency required
- t = time.

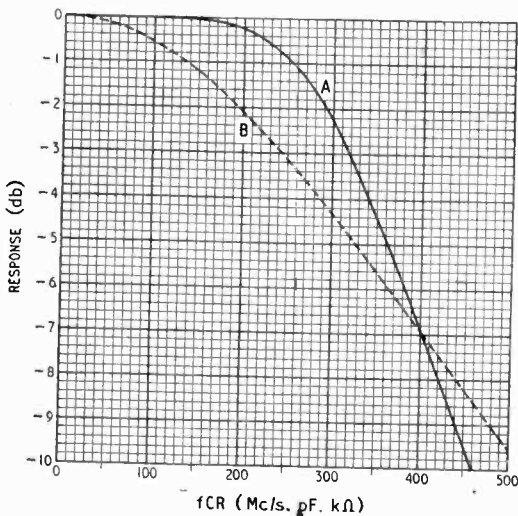

Fig. 2.

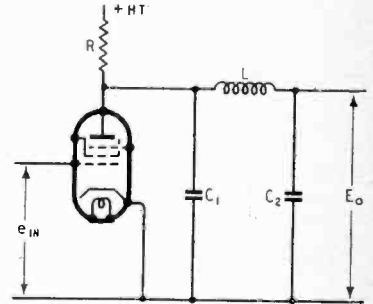

Fig. 1.

**Procedure**

Given the drop in response (db) required at a maximum frequency f, and the total circuit capacitance C, to find the other circuit values:—

(a) for the flattest frequency response

1. Determine fCR from curve A, Fig. 2.
2.  $R = (fCR)/fC$
3.  $A = g_m R$
4.  $L = \frac{2}{3} CR^2$
5.  $C_1 = \frac{1}{4} C$
6.  $C_2 = \frac{3}{4} C$

(b) for critical damping

1. Determine fCR from curve B, Fig. 2.
2.  $R = (fCR)/fC$
3.  $A = g_m R$

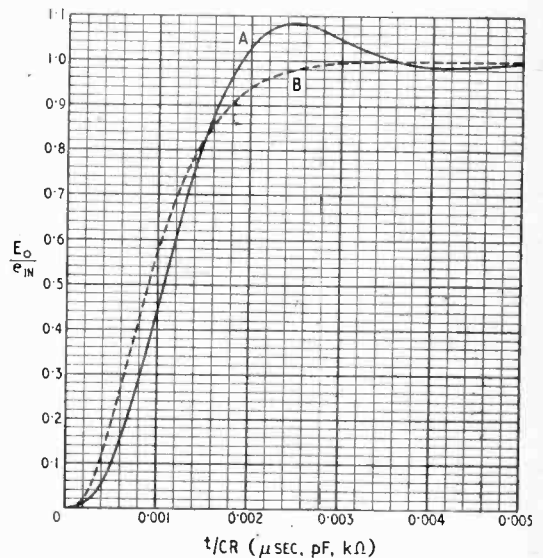

Fig. 3.

4.  $L = \frac{2}{3} CR^2$
5.  $C_1 = \frac{1}{4} C$
6.  $C_2 = \frac{3}{4} C$

Alternatively, given the response required at a given time  $t$  after the onset of a pulse:—

(c) for the flattest frequency response

1. Determine  $t/CR$  from curve A, Fig. 3.
2.  $R = t/C(t/CR)$

Then proceed as in (a) 3—6.

(d) for critical damping.

1. Determine  $t/CR$  from curve B, Fig. 3.
2.  $R = t/C(t/CR)$

Then proceed as in (b) 3—6.

## Units

mA/V;  $k\Omega$ ;  $\mu H$ ; pF; Mc/s;  $\mu sec$ .

## Examples

Assume that  $C = 40$  pF;  $g_m = 6$  mA/V; and that a response of  $-1$  db at 3 Mc/s is required, the condition of flattest frequency response being suitable.

From Fig. 2, curve A,  $fCR = 255$ , so  $R = 255 / (3 \times 40) = 2.12$   $k\Omega$  and from (a) 3,  $A = 6 \times 2.12 = 12.72$ . Also,  $L = \frac{3}{8} \times 40 \times 2.12^2 = 120$   $\mu H$ ;  $C_1 = 40/4 = 10$  pF; and  $C_2 = 3 \times 40/4 = 30$  pF. The conditions can be met only if it is possible so to arrange the circuit that  $C_2$  has three times the capacitance of  $C_1$ .

An alternative is possible, however, for  $R$  can be connected to the output end of  $L$  instead of to the input. This reverses the capacitance ratio; in other words  $C_1$  must then be given the value calcu-

lated for  $C_2$  and  $C_2$  must have that calculated for  $C_1$ . The performance is unaffected.

If the condition of critical damping is utilized, then we start with curve B of Fig. 2, and find  $fCR = 137$ , so that  $R = 1.14$   $k\Omega$ ;  $A = 6.84$ ;  $L = 17.1$   $\mu H$ ;  $C_1 = 4.44$  pF; and  $C_2 = 35.56$  pF.

The pulse response curves are given in Fig. 3 and it should be noted that, unlike those of the shunt-corrector, they have an initial lower bend. This is characteristic of all circuits having a series inductance and it represents a time delay, but is not normally harmful.

However, it is usual to reckon the start of the output pulse as occurring, not at  $t = 0$ , but at some finite output level such as 0.05. If for convenience we compare circuits on the basis of the output pulses being 90 per cent complete, it is better to take the time for an output change from 0.05 to 0.95 instead of  $C$  to 0.9.

Applying this to the two examples above, we find that for curve A of Fig. 3,  $t/CR$  has values of 0.0004 and 0.00175 for outputs of 0.05 and 0.95, so that the value of  $t/CR$  for a change of output of 90 per cent is the difference, or 0.00135 whence  $t = 0.00135 \times 40 \times 2.12 = 0.115$   $\mu sec$ .

Now in the second case we use curve B, and find the values of  $t/CR$  are 0.00028 and 0.0021. The difference is 0.00182 and  $t = 0.00182 \times 40 \times 1.14 = 0.083$   $\mu sec$ .

It can thus be seen that for the same frequency response, critical damping gives a better transient response, but the amplification is much lower.

## "RADIOMOBILE"

AS mentioned elsewhere in this issue a new company has been formed jointly by The Gramophone Co. and Smith's Motor Accessories for the purpose of producing and servicing car-radio equipment.

Whilst the company has as its objective the production of a receiver as an integral part of a car, during the interim period it will be marketing H.M.V. car sets for installation in existing vehicles. It is interesting to note that these sets have been adopted as standard equipment by Rolls-Royce.

The five-valve (plus rectifier) superhet, which covers the medium- and long-wave bands, is available in two styles: Model 100, with push-button controls for tuning, wavechange and tone adjustment, and Model 101, which has manual tuning and no tone control. An interesting feature of Model 100 is that the selection of stations for push-button tuning is accomplished without the aid of tools. The four buttons, which have milled edges, are themselves used for pre-selection.

The receivers incorporate ignition-interference filters, thereby eliminating the necessity for installing

suppressors in the car ignition system.

If space does not permit the installation of the set as a complete unit it is possible to separate the power pack from the receiver. The overall measurements of the set are:  $4\frac{1}{2}$  in high,  $8\frac{1}{2}$  in wide and  $12\frac{3}{4}$  in deep.



**Radiomobile Model 100.** Two push-buttons provide tone control for speech and music, two for wavechange and four for station selection.

H.T. is provided by a non-synchronous vibrator working from the 12-volt car battery. Current consumption is 3.25 amps.

Radiomobile car aerials are also being produced. There are four types; two 33in telescopic rods for roof mounting—both of which are pivoted for "parking," a 6ft telescopic whip aerial for scuttle mounting and one for under-car mounting.

## MANUFACTURERS' LITERATURE

SEVERAL illustrated leaflets have been added to the general catalogue of Standard Telephones and Cables, Connaught House, Aldwych, London, W.C.2. They include the following items: Types S.T.R.9 and S.T.R.12 light aircraft V.H.F. transmitter-receivers, Type P.V.1 automatic direction finder, Type Q.D.1 V.H.F. signal generator, Types Q.E.1 and Q.E.2 centimetre-wave signal generators, Types Q.K.1-4 wide-range cavity wave-meters, Type Q.R.1 impedance comparator for checking up to 100 impedances in three minutes, and Type Q.K.5 direct-reading frequency meter for 10 c/s to 30 kc/s.

Also from Standard Telephones and Cables, we have received a catalogue of P.V.C. insulated set wires, including technical details and a colour chart.

Eddystone short-wave components for transmitters and receivers are described in a new illustrated catalogue issued by Stratton and Co., West Heath, Birmingham.

The properties of Sankey's acid-resisting cement are described in a leaflet issued by J. H. Sankey and Son, Ilford, Essex.

Price list of Ashton Cables from Agrialite, Ltd., Castle Works, Stalybridge, Cheshire.

# BRIMAR VALVES

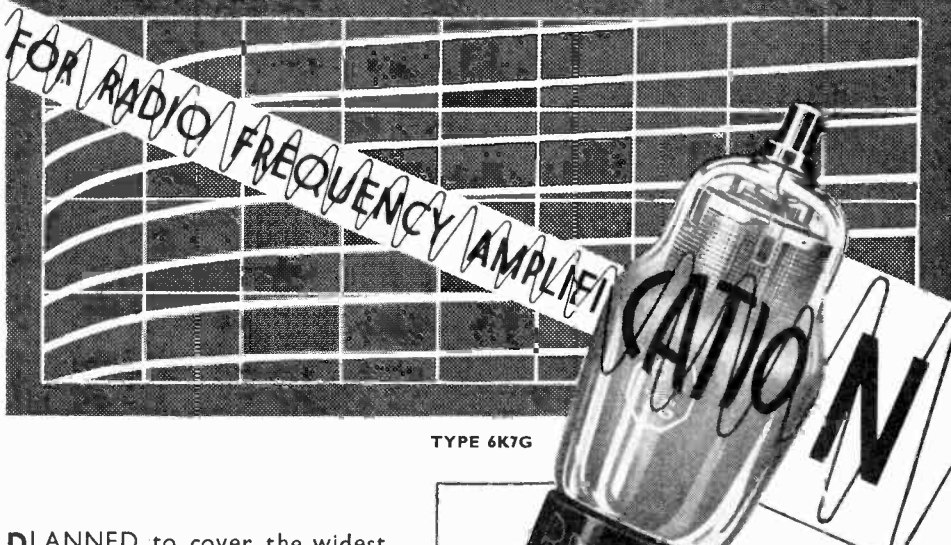

TYPE 6K7G

PLANNED to cover the widest possible field of uses, the BRIMAR range will give you replacements for either British or American receivers. On this page we show valves for R.F. amplification. Equally comprehensive is the list of valves for other purposes — mixers, signal rectifiers, A.F. amplifiers, power output valves and power rectifiers.

# BRIMAR

BVA

# RADIO VALVES

## BRIMAR VALVES FOR R.F. AMPLIFICATION

### ENGLISH

Type	E/F	I/F	Purpose
9A1	4	1	V.mu R.F. Pen.
9A2	13	0.2	V.mu R.F. Pen.
8A1	4	1	R.F. Pen.
8A2	13	0.2	R.F. Pen.

### AMERICAN

6C6	6.3	0.3	R.F. Pen.
6D6	6.3	0.3	V.mu R.F. Pen.
77	6.3	0.3	R.F. Pen.
78	6.3	0.3	V.mu R.F. Pen.

### LOCTAL

1LN5	1.4	0.05	Battery R.F. Pen.
7A7	6.3	0.3	V.mu R.F. Pen.
7B7	6.3	0.15	V.mu R.F. Pen.

### OCTAL

1N5G	1.4	0.05	Battery R.F. Pen.
6J7G	6.3	0.3	R.F. Pen.
6K7G	6.3	0.3	V.mu R.F. Pen.
6U7G	6.3	0.3	V.mu R.F. Pen.
12J7GT	12.6	0.15	R.F. Pen.
12K7GT	12.6	0.15	V.mu R.F. Pen.

### MINIATURE

1T4	1.4	0.05	V.mu R.F. Pen.
-----	-----	------	----------------

STANDARD TELEPHONES AND CABLES LIMITED, FOOTSCRAY, SIDCUP, KENT

# VORTEXION

## "SUPER FIFTY WATT" AMPLIFIER

This **AMPLIFIER** has a response of 30 cps. to 15,000 cps., within  $\frac{1}{2}$  db, under 2 per cent. distortion at 40 watts and 1 per cent. at 15 watts, including noise and distortion of pre-amplifier and microphone transformer. Electronic mixing for microphone and gramophone of either high or low impedance with top and bass controls. Output for 15/250 ohms with generous voice coil feedback to minimise speaker distortion. New style easy access steel case gives recessed controls, making transport safe and easy. Exceedingly well ventilated for long life. Amplifier complete in steel case, with built-in 15 ohm mu-metal shielded microphone transformer, tropical finish. As illustrated. Price 29½ Gns.

**A.C.20 AMPLIFIER CHASSIS.**—This well-known model has been retained, and has a response 30—15,000 cps., mixing arranged for crystal pick-up and microphone, large output transformer for 4—7.5 and 15 ohms to deliver 15 watts at less than 5 per cent. total harmonic distortion to the speakers. Metal Cabinet for above, if required, £3. Price £15 15 0

**RECORD REPRODUCER CHASSIS.**—This is a development of the A.C.20 amplifier with special attention to low noise level, good response (30—18,000 cps.) and low harmonic distortion (1 per cent. at 10 watts). Suitable for any type of pick-up with switch for record compensation, double negative feedback circuit to minimise distortion generated by speaker. Has fitted plug to supply 6.3 v. 3 amp. L.T. and 300 v. 30 mA. H.T. to a mixer or feeder unit. Price £18 0 0 Metal Cabinet for above, if required, £3.



**C.P.20A 15-WATT AMPLIFIER** for 12 volt Battery and A.C. Mains operation. This improved version of the old C.P.20 has switch change-over from A.C. to D.C. and "stand by" positions and only consumes 5½ amperes from 12 volt battery. Fitted mu-metal shielded microphone transformer for 15 ohm microphone, and provision for crystal or moving iron pick-up with tone control for bass and top and outputs for 7.5 and 15 ohms. Complete in steel case with valves. Price £22 10 0

We very much regret that owing to increased costs we are reluctantly compelled to advance all the above prices by 10 per cent.

DEALERS AND EXPORT AGENTS should write for special terms to:—

# VORTEXION LTD.

257-261 THE BROADWAY,  
WIMBLEDON, S.W.19.

Telephones: LIberty 2814 and 6242/3

Telegrams: VORTEXION, WIMBLE, LONDON.

# QUARTZ CRYSTAL UNITS



For your **FREQUENCY STANDARD**

**TYPE JCF/200 LOW TEMPERATURE  
COEFFICIENT BAR**

Frequency . . . 100 Kc/s  
Accuracy . . . ± .01 %  
Price on application.

Vacuum mounted for optimum stability. A high precision unit of extreme stability, the crystal being nodally mounted on fine wires soldered to the bar.

DELIVERY FROM STOCK

For your **TRANSMITTER**

**TYPE 2 LOW TEMPERATURE  
COEFFICIENT PLATES**

3.50/3.75 Mc/s or 7.00/7.50 Mc/s for the  
30 Mc/s band.  
3.66/3.75 Mc/s or 7.32/7.50 Mc/s for the  
60 Mc/s band.

Prices on application.

Supplied for either band for random frequencies or for specified frequencies at slightly increased price.

AVAILABLE FOR IMMEDIATE DELIVERY

## SALFORD ELECTRICAL INSTRUMENTS LTD.

PEEL WORKS, SALFORD 3

Telephones: BLAckfriars 6688 (6 lines).

Telegrams and Cables: "SPARKLESS, MANCHESTER"

Proprietors: **THE GENERAL ELECTRIC Co. Ltd., of England**

# VALUES

## Things That Are Often Obscure

**N**O; this is not a treatise on Inflation or the Black Market, or even on Lisle Street, London, W.C.2. A reader has suggested that there is no small confusion regarding peak, mean and R.M.S. values, especially in relation to the sharp-cornered waveforms that have become fashionable in recent years. I am well prepared to believe him, because the subject is full of catches. Most of the elementary and some of the not-so-elementary textbooks stick strictly to the firm highroad of pure sine waves, and leave the student to make his own way as best he can through the treacherous jungle of pulses, square waves and so on, with their lush harmonic foliage.

Although the most obvious of the three, even the peak value may not be quite beyond dispute. Take Fig. 1(a) for example. Is  $e_1$  the peak value? "Yes" may be right or wrong. To find out which, try Fig. 1(b). If  $e_2$  is given as the peak value, the reason is presumably the same as for  $e_1$ , and is not very sound in either case.

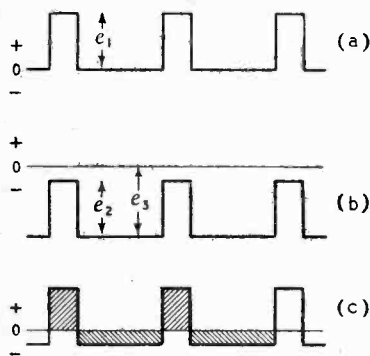

Fig. 1. Is  $e_1$  the peak value in (a)? Or  $e_2$  or  $e_3$  in (b)? The questions are clarified if the A.C. component is separated from the D.C., as is done by shifting the zero level until the areas above and below it are equal (c).

But if  $e_3$  is the answer,  $e_1$  is justifiable too, because if the matter of concern is, say, the possible breakdown of insulation to earth, then undoubtedly  $e_1$  and  $e_3$  are the peak values.

Unless there are stated or obvious reasons to the contrary, however, peak values are generally understood to refer to purely alternating voltages and currents.

By

### "CATHODE RAY"

In which case  $e_1$  is not the peak value in Fig. 1(a), where alternating and direct are mixed. The practical way of sorting them out is to put a condenser in series, which stops the D.C. Why? The reason is that current flowing in one direction into a condenser causes a charge to accumulate, and if it kept on accumulating the resulting back voltage would soon cut off the current. Charge is current multiplied by time, so is represented by the shaded areas in Fig. 1(c) if that is a current waveform (or a voltage waveform in a linear circuit—i.e., one in which the current is exactly proportional to the voltage).

A purely alternating current, then, is one for which the shaded areas above and below the zero baseline in the diagram are equal and so exactly cancel one another out in any one or more whole cycles. And as the mean current is the charge divided by the time, an alternating current must be one in which the mean value taken over each whole cycle is nil. So all one has to do to convert a mixed A.C. and D.C. waveform into an A.C. one is to shift the baseline up or down until the areas above and below it are equal.

If, as in Fig. 1(c), the waveform is unsymmetrical about the baseline, it has two different peak values—one positive and one negative. So there is nothing to be mystified about if one's diode voltmeter (which responds to peak values, notwithstanding that the scale may be plainly marked "R.M.S.") reads differently when its connections to an alternating source are reversed.

If there is likely to be any confusion about peak values it may be better to specify the

peak-to-peak value, the meaning of which is quite obvious.

Mean, or average, values are reasonably easy, too. We have just noted that an alternating current or voltage is, by definition, one in which the mean value over any whole number of cycles is zero. That is an excellent reason why true mean values are not used for specifying the strength of A.C. A moving-coil meter reads mean values, and so can only indicate the presence of A.C. incidentally, by vibration of the pointer, or by emitting clouds of smoke.

Of course, if we either suppress the negative parts, or reverse them so that they add up with the positive parts, a moving-coil meter can be made to give a reading, which is the mean value of the D.C. obtained by half-wave or full-wave rectification respectively and does give some sort of comparative idea of the strength of the alternating current. The result—if a perfect full-wave rectifier is used—at least is the same whichever way round the A.C. is connected.

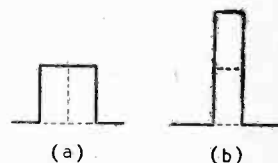

Fig. 2. These two half-cycles obviously have equal mean values, but the R.M.S. values are easily found to be very different.

But does it give a fair comparison? Fig. 2(a) and (b) are sample half-cycles of two imaginary (we hope!) A.C. supplies, both of the same frequency (b) has twice the amplitude for half the duration of (a), so the mean values over the half-cycle are the same. But the heat or power delivered to a given circuit is proportional to the square of current or voltage, so is four times as much with (b) while it lasts, and therefore twice as much per half-cycle or per any number of half-cycles. The (b) waveform of current or voltage is therefore  $\sqrt{2}$  (= 1.414) times as effective for delivering power as (a), although it has the same mean value.

### Values—

So the popular rectifier-cum-moving-coil type of meter, which would represent (b) as being exactly equal to (a) when in fact it is over 40 per cent more powerful, falls down rather badly, at least with this sort of waveform.

The peak type of meter, on the other hand, would make out that (b) was 100 per cent greater than (a), so would err in the opposite direction.

The most useful way of reckoning and measuring voltages, etc., is one that enables them to be compared on the basis of how much power they represent. We actually did this with Fig. 2. What we did was to square the voltage (to put it on a wattage footing), find its average, and then take the square root to bring it back to volts. That is why it is called the *root-mean-square* or R.M.S. value. (An alternative term is *effective* value.) You will remember that one snag about applying mean values to A.C. is that when taken over any complete cycle they are (by definition of A.C.) invariably nil. But following the R.M.S. procedure the negative half-cycle becomes positive in the squaring, and although when taking a square root the result ought really to be marked "±" it is too late to sort out the contributions of the individual positive and negative half-cycles, because they have been inextricably stirred together in the process of taking the mean, and any + or - sign would have to apply to the whole cycle or nothing.

Some types of meter, for various reasons, deflect in proportion to the R.M.S. value, so their calibrations hold good for all waveforms. For example, all instruments depending on heat (because heat is proportional to  $I^2$ ), moving-iron and dynamometer types (because both fixed and moving magnets depend directly on the current, and hence their interaction on  $I^2$ ), and some valve voltmeters (if adjusted to work on a part of the valve curve that is a close approximation to a square law). As rectifier types of meter, and peak valve voltmeters, scaled in R.M.S. values for use with sine waves only, are much more commonly used nowadays by readers

of *Wireless World*, it may be interesting to have some idea of how much error there is when they are used to measure A.C. of other waveforms.

To do this it is necessary to know the relative peak, mean and R.M.S. values of the sine waveform. As that is a little complicated, let us dispose of the square and rectangular waves or pulses first, because it is easiest to take the average of something that stays the same all the time it is on.



Fig. 3. The square wave is the easiest for which to compare values.

For shorthand let us make  $\hat{e}$  stand for peak value,  $\bar{e}$  for mean (over a full-wave-rectified cycle), and E for R.M.S. (over a cycle). And although it may be convenient to think of voltage, the same principles apply to current, magnetic flux, pressure of sound, and any other magnitudes that can have waveforms.

If the positive and negative parts of a perfectly square-cut wave are of equal duration they must also be of equal amplitude, as in Fig. 3. (Otherwise there would be a positive or negative D.C. balance in hand). The effect of a perfect full-wave rectifier is to reverse the negative part, so that the voltage throughout the cycle is equal to the peak value,  $\hat{e}$ . In other words,  $\bar{e} = \hat{e}$ . (But note that if a half-wave rectifier is used the mean value is half  $\hat{e}$ ). The square of the voltage is  $\hat{e}^2$  all the time, so the mean of the square

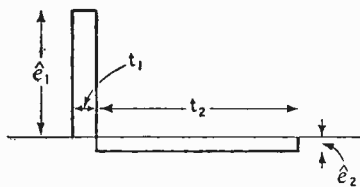

Fig. 4. In this wave,  $t_2$  is 9 times  $t_1$ , so  $\hat{e}_1$  is 9 times  $\hat{e}_2$ .

is also  $\hat{e}^2$ , and the R.M.S. is  $\hat{e}$ .  $E = \hat{e} = \bar{e}$ . (I said this was easy).

Now for unequal "half" cycles, Fig. 4. Remember the process of taking a mean is (a) multiply

each different voltage or whatnot in the cycle by the time it remains constant, (b) add the results of (a) together, and (c) divide by the time of a whole cycle. As there is supposed to be no D.C. mixed up with any of these waves, the mean values of the positive and negative parts are equal. So  $\bar{e}$  of the whole is twice that of either part. Doing the whole process at one go,

$$\bar{e} = \frac{2\hat{e}_1 t_1}{t_1 + t_2}$$

For example, if the positive part lasts one tenth of the whole

cycle,  $\bar{e} = \frac{2\hat{e}_1}{10} = \frac{\hat{e}_1}{5}$ . Incidentally,

of course,  $\hat{e}_1 = \hat{e}_2 \frac{t_2}{t_1}$ , so  $\bar{e} = \frac{9\hat{e}_2}{5}$ .

For the R.M.S. value the voltages have to be squared before taking the mean, and the square root of the result taken. Doing this,

$$E = \sqrt{\frac{\hat{e}_1^2 t_1 + \hat{e}_2^2 t_2}{t_1 + t_2}}$$

a rather alarming-looking result.

But remembering  $\hat{e}_2 = \hat{e}_1 \frac{t_1}{t_2}$  and substituting in the above, a little slimming with the aid of Colebrook's "Mathematics for Radio Students" soon reduces it to

$$E = \hat{e}_1 \sqrt{\frac{t_1}{t_2}}$$

In the above example (where  $\bar{e} = \frac{\hat{e}_1}{5}$ ), E turns out to be  $\frac{\hat{e}_1}{3}$ , or

$3\bar{e}$ . So  $\bar{e} = \frac{3E}{5}$ , and if a rectifier-

type meter had been calibrated with a Fig. 3 wave to read R.M.S. values, it would read 40 per cent low with the Fig. 4 wave. A peak voltmeter similarly calibrated would read 66⅔ per cent low if connected one way and 200 per cent high if connected the other way.

The general conclusion seems to be that for measuring things with waveforms of this sort it is advisable to choose an instrument that not only bears a scale marked in the kind of value required but actually does measure that particular value.

How about sine waves now? As soon as one tries to take the mean one runs into the difficulty

that the voltage never stays put for even the smallest period of time. One way out is to draw the curve on paper and find the mean height by measuring the area between it and the baseline, and then dividing by the length of the base. Unless one has a planimeter that is so tedious that it may be less trouble to learn the integral calculus (see Colebrook again) and do it the proper way, which gives the result that the mean of a

positive half sine wave is  $\frac{2\bar{e}}{\pi}$ , or  $0.637\bar{e}$ .

The R.M.S. value can quite easily be found by the curve-drawing method, however, because when a  $\sin^2$  curve is plotted, as in Fig. 5, it is seen to be equally above and below the half peak height line, so the mean square

value is  $\frac{\bar{e}^2}{2}$  and hence the R.M.S. value is  $\frac{\bar{e}}{\sqrt{2}}$ , or  $0.707\bar{e}$ .

So for a sine wave  $E = \frac{0.707\bar{e}}{0.637} = 1.11\bar{e}$ . A moving-coil meter that reads up to 100 volts D.C., and is then adapted for A.C. by fitting it with a full-wave rectifier, therefore needs 111 volts R.M.S. to give full-scale reading. If a 0-111 volt scale is provided

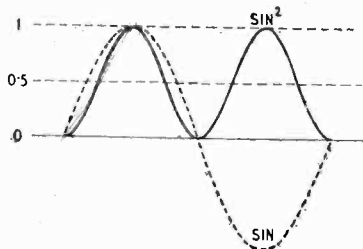

Fig. 5. Showing how to arrive at the R.M.S. value of a sine wave.

accordingly,\* it will read R.M.S. values correctly so long as  $E = 1.11\bar{e}$ . But if, for example, the Fig. 3 wave is applied, for which  $E = \bar{e}$ , it will read 11 per cent. high.

The ratio  $E/\bar{e}$ , which is the clue to all this, is called the *form factor*. It was invented in the early days of electrical engineering,

\* The need for a separate A.C. scale is avoided in practice by making the D.C./A.C. switch alter the range resistances.

I have no idea by whom; and all the books I have looked up are pretty vague about it. Even the British Standards Institution, which ought to know better, defined it as recently as 1943 as "the ratio of the R.M.S. value of an alternating wave to its mean value taken over half a period beginning at a zero point." That is all right so long as the positive and negative parts each last for half a period (cycle), but the definition falls down with Fig. 4, and with certain waves having harmonics greater than the fundamental. No doubt the staid old heavy electrical engineers never imagined anyone would be so crazy as to want to use such waves.

Incidentally, a wave does not *have* to be of sine form in order to have a form factor of 1.11. Certain quite considerably distorted waves have the same form factor, but it would be a fluke if one ever came across them with a meter. So in general an error is to be expected when a non-sine wave is measured with a pseudo-R.M.S. meter.

Now we may be able to shed a little light on one of those things that is often left obscure. The books tell us that if you add harmonics ( $E_2, E_3$ , etc.) to a sine wave fundamental ( $E_1$ ) the R.M.S. value of the lot is calculated this way:

$$E = \sqrt{E_1^2 + E_2^2 + E_3^2}, \text{ etc.}$$

The phases of the harmonics don't matter a jot, apparently; and any harmonics at all are bound to increase the R.M.S. value as a whole. "But surely," you may say, "a harmonic adds bits on here and takes an equal number of equal bits off there, so how can it increase the total? And as for phase, compare (a) and (b) in Fig. 6, where a 3rd harmonic is shown. In (a) each half-cycle of the fundamental is strengthened by two half-cycles of harmonic and weakened by only one, whereas in (b), where the only difference is that the harmonic has been shifted along half a cycle in phase, the fundamental is actually reduced twice as much as it is increased. So how can the net result be an increase, as the formula above makes out?"

It is true that the harmonic increases the *mean* value in Fig. 6(a), and decreases it by the same amount in (b). But if you have been following this story you should have noticed that a wave of a given mean value has a much higher R.M.S. value if it is gathered up into a peak than if it is spread out along the baseline. Fig. 2 was a particularly clear example of this. In Fig. 6(b), the single harmonic half-cycle in the middle outweighs the two at each side because it comes right on the fundamental's peak, whereas the others merely take away the skirts that had very little R.M.S. value anyway. In Fig. 6(a) the peak is cut down, it is true, but both sides are built up to something approaching peak level.

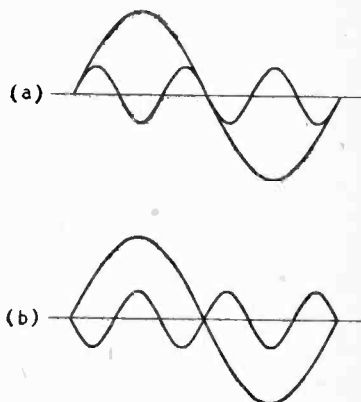

Fig. 6. When this third harmonic is added to the fundamental, how does it affect the various values in each case (a and b)?

It is not at all obvious, and indeed is very remarkable, that both (a) and (b), and in fact any intermediate phases, and any harmonic of the same amplitude, should in every case add up with the fundamental to exactly the same R.M.S. value; but there it is.

As a matter of interest, if you were to analyze any of the pulses and square waves such as Figs. 1-4 into their component fundamentals and harmonics, and then add up the R.M.S. values by the formula last given, you would find that they would agree with what we have already found the easy way. Try it if you want to know what to do with the long

**Values—**

winter evenings. The story on p. 358 of the December 1945 issue gives you a start.

Lastly, if you have occasion to measure currents and voltages in power rectifier circuits it would be a good thing to bear this value business in mind. All sorts of rather extreme waveforms are likely to occur and make nonsense of meter readings. For example, the current in a rectifier valve circuit is often very much of the Fig. 2(b) variety, giving high R.M.S. and peak values in relation to the mean, so the ordinary rectifier-type meter gives little clue to the transformer heating effect or to the maximum current the valve is carrying.

**HIGH-FIDELITY "ELECTROGRAM"**

THE prototype of a new high-fidelity electrical reproducing gramophone was demonstrated recently by H.M.V. It is housed in two separate cabinets, the larger containing the loudspeaker units and the smaller the amplifier, record changer and controls. Thus the operation of the equipment can be carried out at listening distance.

The loudspeaker array comprises two large cones for the low frequencies and a light ribbon-type unit for the high frequencies, with a cross-over filter network. The frequency range is 30 to 12,000 c/s, and the power handling capacity is 12 to 15 watts undistorted. Particular attention has been given to the reproduction of transients.

A record changer of new and simplified design has been developed, and the pick-up, which works with a weight of 1 oz at the needle point, normally uses chromium-plated miniature steel needles; fibre or sapphire points can also be used.

The instrument is not yet in production, and the price is not known.

# HEARING-AID RECEIVERS

## New Designs for Home and Schoolroom

WE have recently had an opportunity of examining two new products of Multitone Electric Co., 92, New Cavendish Street, London, W.1, in which the interests of radio listeners with defective hearing have been carefully studied.

The latest Multitone Radio Set for the Deaf not only provides a separate headphone channel for broadcast listening, but includes a complete mains-operated hearing aid which can be brought into use by a fourth position of the wave-range switch.

The main radio circuit is a super-het consisting of frequency changer, I.F. amplifier, double diode triode, and pentode output valves in push-pull giving about 5 watts. Quality of reproduction in the loudspeaker is above average and the sensitivity is also remarkably good on all three wavebands. Particular attention has been given to the reduction of mains hum which is less than 1 per cent.

Independent volume controls of the constant impedance type are provided for the parallel headphone and L.S. outputs, so that the deaf person can enjoy the full output of the set without embarrassing other members of the household. The headphone channel is provided with volume compression and the principle of unmasked hearing can be applied by suitable filters in the phone leads to suit the listener's individual requirements.

In earlier Multitone hearing aid receivers, the loudspeaker was used as a microphone, but in the present model a separate piezo crystal microphone is employed. An auxiliary valve is used to give audio A.V.C. of short time constant. The degree of A.V.C. is adjustable by a pre-set control on the back of the set and the circuit is very effective in protecting the listener from the nervous strain of accidental and unexpected noises of abnormal intensity.

The price of the complete eight-valve receiver is £42 plus tax £8 8s.

The school installation comprises

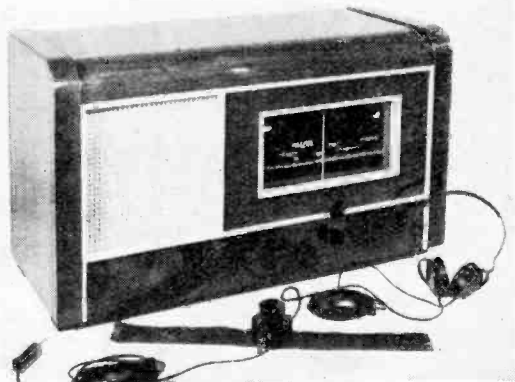

Broadcast receiver with independently controlled output for headphones. A switch converts the set to a mains-operated hearing aid.

separate radio receiver and amplifier units, the former similar in design to the home hearing aid receiver, but with a voltage output from the signal diode. The amplifier is designed to feed headphones up to twenty in number.

The input circuit to the amplifier provides mixing for radio, gramophone and speech from a sound cell type microphone, so that the teacher can interject comments. The amplifier is in two parts, both with automatic volume compression. One handles all frequencies and the other high frequencies only, and the circuit is so arranged that the contribution of the high-pass amplifier increases as the total volume increases. This is the principle of Differential Compression which has been developed recently by the Multitone Company.

The outputs are fed by a three-valve system to individual volume controls for each child, so that the ratio of high frequencies can be adjusted independently in each case.



Multitone School Installation, Mark II, with one of the headphone control units. A sound-cell microphone (not shown) is included.



# BELLING-LEE QUIZ (No. 4)

Answers to questions we are continually receiving by letter and telephone

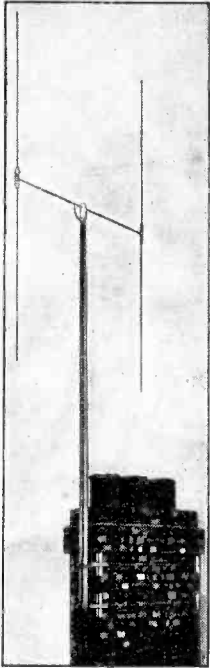

**Q.18.** Will a television aerial become "out of date" in a short time?

**A.18.** While there may be technical improvements in television receivers as well as in the B.B.C. transmissions, it is not anticipated that they will necessitate a new installation or will alter the degree of efficiency of Belling-Lee aerials.

**Q.19.** How long will a television or Skyrod\*<sup>1</sup> aerial last?

**A.19.** This depends chiefly upon (1) the weather resisting properties of the aerials, (2) the geographical location, and (3) care taken during erection. The former and latter considerations are very closely linked, for an excellent protective finish can easily be nullified if damage is caused by careless handling. All types of our aerials are made of steel which has been zinc-plated and passivated. This measure of protection should give a normal life of several years, unless the plating has been damaged, or the aerial is situated in the salt-laden atmosphere of coastal districts or has been erected near furnace chimneys which are continually emitting heavy sulphurous fumes. There is not much use paying a higher price for a well-finished aerial if during erection

it is hauled up to the roof and scraped over the iron gutter or rough parapet. The finish of Belling-Lee aerials is as good as is practicable, but the best could be improved by the addition of a coat of good paint if the conditions are likely to be severe.

The aerials are guaranteed for one year, and it is advisable to inspect an installation every twelve months, adding a coat of good paint if necessary.

We have on record television aerial installations which have received no maintenance for the duration of the war, and on being tested and examined were found to be in extremely good condition. One cannot, however, rely on such results.

**Q.20.** Are Belling-Lee\*<sup>2</sup> Television Aerials suitable for all sets?

**A.20.** For optimum results on a certain frequency a dipole aerial must be of the correct dimensions. Where a reflector is incorporated, we recommend that it be spaced a distance of one quarter wave-length behind the dipole.

All the necessary characteristics have been most carefully considered in the design of our aerials based on the requirements of the B.B.C. television transmissions. We can therefore confirm that they are suitable for use with any type of T.V. receiver using a feeder cable\*<sup>3</sup> of 70-80 ohms impedance.

**Q.21.** Is steel the best type of metal for manufacture of Television aerials?

**A.21.** Not necessarily. Copper alloys are normally used for horizontal wire aerials, but in rod or tube form the cost of copper alloy would rise very considerably before it would be possible to reach the rigidity which is necessary to prevent mechanical distortion during assembly, erection, or under gale conditions (see question 9 repeated below).

Owing to shortage of steel, aluminium may temporarily have to replace our zinc-plated steel tubes.

**Q.9. (Repeated from Quiz No. 2.)** Why make Television aerials of expensive rigid construction? Will a wire not do just as well?

**A.9.** A Television aerial is really a tuned circuit which has been pulled out of compact shape. It therefore possesses a measure of selectivity. The reason for making the element of fairly large diameter is because it

is known that this flattens the response and thus makes it more certain to produce high definition (sharp focus). This particularly applies now that the bandwidth of the transmission has been increased, and if receiver designers take advantage of the higher quality of transmission, a deterioration of definition might be observed if the present rigid dipole element were replaced by, say, 7/22 copper wire.

**Q.22.** Is there a greater risk of lightning where a Television aerial is installed?

**A.22.** No. The risk to the building is not increased, and it is a fact that Insurance Companies do not consider the installation of an aerial of any reasonable type as justification for increased insurance rate.

If an additional safeguard is required the Belling-Lee lightning arrester\*<sup>4</sup> L.376 is available for L.336 balanced twin feeder. This type contains a carefully adjusted spark gap between carbon electrodes through the perforation in a high-grade mica disc, and can be fixed at any point on the feeder between the aerial and receiver.

\*<sup>1</sup> Skyrod (Reg. Trade Mark).

Types L.355/CK 12' collector, down-lead, 2 transformers, pole clamps and earth wire ... £7 2 6

L.355/LK with chimney lashings and brackets in addition ... £8 8 0

L.370/LK with chimney lashings for 2" mast in addition to L.355/CK £9 10 0

Also supplied with 18' collector. Write for our abridged catalogue for fuller details.

\*<sup>2</sup> Viewrod (Trade Mark).

Dipole, reflector and cross arm with chimney lashings, L.502/L each £5 5 0

Supplied also without reflector and/or chimney lashings from £2 3 6

\*<sup>3</sup> L.336 Balanced twin feeder 6d. per yard extra.

\*<sup>4</sup> L.376 Lightning arrester each 9 6 Temporarily in short supply.

**BELLING & LEE LTD**  
CAMBRIDGE ARTISIAL ROAD, ENFIELD MIDDLESEX

There is a TANNOY SPEECH BROADCASTING INSTALLATION to suit your requirements

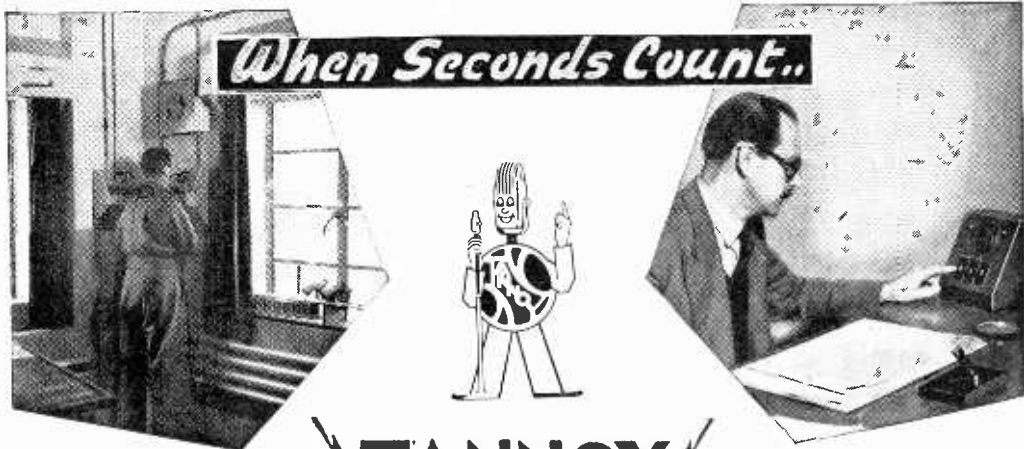

*When Seconds Count..*

**TANNOY**  
CALL SYSTEMS CREATE EFFICIENCY!

"Tannoy" is the registered trade mark of equipment manufactured by

**GUY R. FOUNTAIN, LTD.**

"THE SOUND PEOPLE"

West Norwood, S.E.27, and Branches  
Gipsy Hill 1131



The largest organisation in Great Britain specialising SOLELY in Sound Equipment.

**D.I.S.T.A.N.C.E**  
is no object . . .

If your object is to make Sound travel the farthest distance in just one required direction, a VITAVOX Beam Projector Loudspeaker incorporating a VITAVOX pressure type unit is the answer . . . it is designed to make "distance no object" but at the same time to provide natural reproduction of speech.

This type of loudspeaker is weatherproof and therefore ideally suited for use in the open air. You can learn more about the Vitavox Beam Projector Loudspeaker if you will write to us. . . . we shall be glad to assist you.



MODEL B.P.28  
Retail Price  
**COMPLETE £16 0 0**

Obtainable from Vitavox Accredited Wholesalers. If any difficulty is experienced, please write direct to us.

**VITAVOX**  
**BEAM PROJECTION LOUDSPEAKER**

Vitavox Ltd., Westmoreland Road, London, N.W.9. Tel. Colindale 8871-3

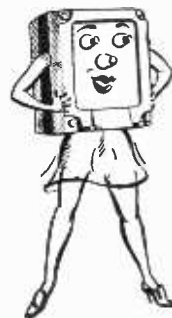

**THANKS**  
for the  
**COMPLIMENTS**

**WODEN** DE LUXE  
TRANSFORMERS

DESERVEDLY WIN UNIVERSAL PRAISE

From the day we sold the first of our "de Luxe" Range of Mains and Filament Transformer they have received quite a "fan mail" from users the world over expressing entire satisfaction on their performance under all conditions. Mind you—and please don't think us conceited—we are not surprised because we really did do a good job with the "de Luxe" Range as can be judged from their Superb Technical Design — Finest Quality Materials — High Operational Efficiency — Guaranteed Reliability — Beautiful Appearance. Why not send for further details and full specifications TO-DAY.

**WODEN TRANSFORMER CO. LTD.**  
MOXLEY ROAD · BILSTON · STAFFS.  
Telephone - Bilston 41959

# World of Wireless

## 514 METRES

THE recent announcement that the U.S.S.R. is to use the wavelength of 514.6 metres (583 kc/s) for a new transmitter at Riga, Latvia, has caused some consternation in this country, for it will be remembered that the B.B.C. had intended to use this wavelength for its "third programme" planned for the end of September.

According to the Lucerne Plan, which, although over twelve years old, is still operative, the 583-kc/s channel was allocated jointly to Tunisia and Latvia. The 50-kW Latvian station at Madona was wrecked by the Germans and has been out of commission for the past three years. As the frequency was not being used by a Tunisian station, the French Government made use of it for the 15-kW Grenoble station which, under the Lucerne Plan, was allocated 968 kc/s for a new 120-kW transmitter.

When France was overrun by the Germans, it will be recalled, they made use of the 583-kc/s channel for the "Calais" station. When, in turn, the Allied Forces liberated France, the frequency was made available to the B.B.C. for the Service to the Allied Expeditionary Forces and was later used for the Western Regional.

## FIVE-POWER CONFERENCE

AT the invitation of the Soviet Union delegations from the U.K., U.S.A., China and France are meeting in Moscow at the end of September for a five-power telecommunications conference. The purpose of the meeting is to give preliminary consideration to the questions which will be discussed at the meeting of the International

## "QUEEN ELIZABETH"

Part of the main control and receiver room in the Cunard White Star Company's 83,673-ton "Queen Elizabeth." The radio equipment, installed by the International Marine Radio Company (London) was proven during the ship's years of war service. Operating positions shown are (left to right); radio-telephone, S.W. telegraph and M. and L.W. telegraph.

Telecommunications Union to be held early next year.

The British delegation will be led by Col. Sir Stanley Angwin, G.P.O. chief engineer.

## GOVERNMENT TRAINING

IT may not be generally known that under the Government's "Further Education and Training Scheme" provision is made for training in radio engineering.

The scheme is primarily intended for those who have served in the Armed Forces, Merchant Navy, Civil Defence Services and those whose training has been interrupted by employment in other work of national importance. It provides for whole-time or part-time training at an educational establishment and also financial assistance for tuition fees and family maintenance allowances.

Of the 7,000 or more awards for training made since the introduction of the scheme only 26 have been for radio engineering.

Applications and enquiries for details should be made to the nearest Regional Appointments Office of the Ministry of Labour and National Service.

## LICENCES

A NEW record has been set up for the number of receiving licences in Great Britain and Northern Ireland. The total is now 10,673,000.

This total includes 1,750 television licences, but this figure cannot be taken as an indication of the number of television sets in use as viewers with unexpired 10s broadcast licences are permitted to operate a television receiver until the existing licence expires.

## RADIO NAVIGATION

DELEGATES from nearly fifty countries attending the series of demonstrations in this country of radio and radar aids to civil aviation were addressed by Sir Robert Watson-Watt at the opening plenary session of the special radio technical division of P.I.C.A.O. (Provisional International Civil Aviation Organization).

During his address, which outlined the advances made in this country's application of wartime radio and radar gear to the needs of civil aviation, he said "We shall . . . be suggesting that 'Gee' should form the basis of the traffic control and short-range navigation systems that are proposed for regional adoption in Europe in the first instance."

He stated that he thought it would be practicable to give long-range guidance of the kind offered by Loran on the same airborne indicator as that used for the improved forms of Gee giving short-distance and traffic-control information. He said he looked forward to a happy re-marriage, in the interests of civil aviation, of Gee (British) and Loran (U.S.A.) which ran so smoothly during the war.

At the conclusion of the meetings in this country, delegates will go to the U.S.A. for demonstrations of American gear before going on to Montreal for further discussions.

## GOVERNMENT RESEARCH

THE doubt expressed some months ago as to the continued existence of the Telecommunications Research Establishment (T.R.E.), Malvern, as a separate entity has been dispelled by the Ministry of Supply's announcement that all its

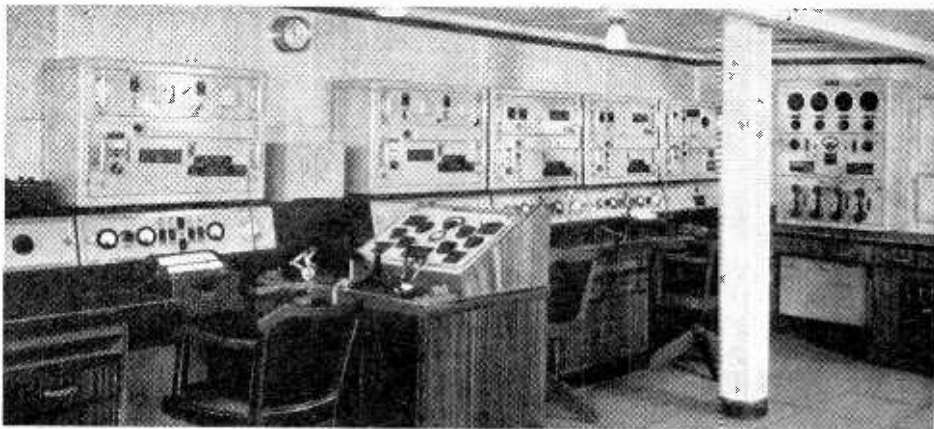

### World of Wireless—

radio research establishments are to be retained.

It is interesting to note that the four research establishments, T.R.E. (Malvern), Radio and Radar Development Establishment (Malvern), Signals Research and Development Establishment (Somerset, Hants) and Royal Aircraft Establishment (Farnborough) will be controlled by a co-ordinating secretariat at the Ministry.

In addition to these M.O.S. research centres there is, of course, the Admiralty Signal Establishment at Haslemere.

### OCEAN NEWSPAPERS

WHEN the *Queen Elizabeth* sails on her maiden voyage on October 16th, the publication of the *Ocean Times* will be resumed as the official daily newspaper for Cunard White Star liners. The *Ocean Times* has been published since 1920 by Wireless Press, Ltd.—our publishers prior to 1925 and now our associates.

The news service—Shipress—on which the ocean newspapers rely is transmitted from the G.P.O. station at Rugby. This service was continued throughout the war although the publication of ocean newspapers was discontinued.

The radio equipment, installed by I.M.R.C., is illustrated on the previous page. Radar gear has been fitted by Cossor.

### EXPORTS

ACCORDING to the latest Board of Trade figures the exports of radio sets during July totalled more than 35,500—five times the pre-war figure.

The total value of the radio exports during the first seven months of this year was over £3.2 million. It is interesting to see the countries to which the most valuable of radio equipment was sent. India received £407,000 worth; Netherlands, £196,400; Norway, £194,100; South Africa, £192,000; Sweden, £172,100 and Australia, £108,500.

### SPEEDING THE PLOUGH

THE latest application of radio control was demonstrated by a manufacturer of farm implements when a plough was successfully handled by an operator in a control van.

The radio equipment and the servo-motors, which automatically operate the tractor controls by compressed air, were fitted by the Automatic Control Section of the Royal Aircraft Establishment. The transmitter, working on 60 metres, and operated by a simple eight-position control unit, was housed in the control van.

Commenting on the practical application of the system, demonstrated by Tractors (London), Ltd., our associate journal, *The Farmer & Stock-Breeder*, suggests that it could permit the control of a battery of

six or more small tractors by one operator, thereby providing a "divisible tractor" adaptable for large or small jobs.

### TELEVISION TESTS

AS a result of a request from the British Radio Equipment Manufacturers' Association the B.B.C. has extended its television test transmissions for a further two half-hourly periods each week-day.

The first of these additional periods precedes the afternoon programme transmission—from 2.30 to 3 and the second follows it—normally from 4 to 4.30.

### SOUND ON FILM

A NEWLY equipped studio for photographic sound recording on 16 mm film has been opened by United Motion Pictures at 24, Denmark Street, London, W.C.2. The studios may be hired, either by professionals or amateurs, for the preparation of commentaries on instructional films, etc., and full facilities are provided for mixing sound effects or music from disc recordings or radio.

The sound recorder, which has been developed by H. H. Waters of U.M.P., is a precision instrument with many interesting features. The variable density method has been adopted, with a gas discharge glow lamp source and the quartz lens has a focal length of only 0.004 inch. A photoelectric attachment enables the recorder to be used for playback—after development of the film, of course.

A demonstration film showed good transient response and a wide frequency range at the standard speed of 24 frames per second and it is claimed that good speech and music can be recorded at the old film speed of 16 frames per second—a point of interest to those who may be still using earlier projectors.

### GUERNSEY TELEVISION

OUR recent reference to the pre-war reception of the Alexandra Palace television transmissions by F. T. Bennett of Guernsey has brought forth a letter from him and a copy of *The Star*, Guernsey, reporting frequent and heavy interference with reception on the island.

It appears that the G.P.O. is using a radio-telephone link between the island and this country, the fundamental frequency of which is approximately 47 Mc/s. This frequency-modulated transmitter is located about a mile and a half from Mr. Bennett's house which is in the direct beam. During telephone transmissions the modulation pattern is received on the C.R.T. on top of the carrier.



Radio equipment and automatic control gear mounted on the plough for the tests mentioned above. ("The Farmer & Stock-Breeder" photograph.)

**PERSONALITIES**

**Sir Edward Appleton, K.C.B.**, recently visited Norway for a ten-day lecture tour arranged by the British Council in co-operation with the Royal Norwegian Society.

**Sir Noel Ashbridge, Deputy Director-General, B.B.C.**, has been nominated vice-president of the American Institute of Radio Engineers for 1947.

**J. Baggs** has been appointed by the G.E.C. as industrial electronic instrument engineer for the N.W. area. In this capacity he will be responsible for technical advice and sales work regarding the electronic products of the company's works at Salford, where, for the past eight years, he has been publicity manager.

**H. G. Faulkner, M.B.E.**, who as Wireless Staff Officer at "Monty's" H.Q. was a Major in Royal Signals, has been appointed radio components sales manager of the Plessey Company.

**C. O. Stanley** has been appointed chairman of the Board of Pye, Ltd., in succession to Sir Thomas Polson, who has resigned owing to ill health.

**IN BRIEF**

**Radiolympia.**—The Radio Industry Council is planning to hold the first post-war radio exhibition at Olympia in late September or early October, 1947.

**U.S. Morse.**—The United States Information Service advises us of the following schedule of bureau transmissions of official news bulletins:—

	Mc/s	G.M.T.
WGEX	17.880	1345-2300
	9.855	2315-0645
WLWR2	12.967	1345-0300
	9.897	0315-0645
WCDA	13.442	1345-2215

**Radio Mathematics.**—A mathematical group is to be formed by the Brit.I.R.E. in the near future for the purpose of holding informal discussion meetings on mathematical problems of direct concern to the radio engineer.

**Evening Classes.**—Among the subjects for which evening classes are provided at the L.C.C. schools and colleges are:—acoustics, electronics, magnetism and electricity, radio engineering, telecommunications and television. Details are given in the Council's guide to evening classes, "Floodlight," price sixpence.

**Telecommunications Engineering.**—Revised regulations for a grouped course in telecommunications engineering have been prepared by the City and Guilds of London Institute. This five-year part-time evening course, requiring attendance on three evenings a week during the September-April session, groups together the separate courses in telephony, telegraphy, and radio-communication previously provided, but provision is made for specializing in radio if desired. The syllabus is obtainable from the Department of Technology, 31, Brechin Place, South Kensington, London, S.W.7.

**Amateur Frequencies.**—The foreshadowed release by the Admiralty of the 85 kc/s below the 1.8-2.0 Mc/s band for use by amateurs in the British Isles on a shared basis was announced by the P.M.G. on August 20th. The band width is now 1.715-2.0 Mc/s. Power is still limited to 10 watts. The additional frequency bands of 3,500-3,635 and 3,685-3,800 kc/s have also been made available to European amateurs on a shared basis. Power is limited to 25 watts for Class A (W/T) and 150 watts for Class B (R/T and W/T), as in the case of 7, 14 and 28 Mc/s.

**Great Circle Map.**—The recent announcement in the lay Press that the Admiralty has issued a world chart "showing accurately for the first time the exact bearing and distance of any place in the world from London by the shortest route" prompts us to recall that the "Wireless World Great Circle Map" was published many years ago. It first appeared as a supplement to the 1922 edition of "The Yearbook of Wireless Telegraphy and Telephony" published from the offices of *Wireless World*. The author was the late J. St. Vincent Pletts, whose original Zenithal Azimuthal projection was published in the May, 1919, issue of this journal.

**Portable Licences.**—It should have been pointed out in our note last month regarding the issue of portable amateur licences that the arrangement does not include organized field days, for which permission is granted free of charge.

**Inaugural Addresses.**—The new president of the I.E.E., V. Z. de Ferranti, M.C., will give his inaugural address on October 3rd. Prof. Willis Jackson, D.Sc., D.Phil., will give his inaugural address as chairman of the Radio Section on October 9th. Both meetings will begin at 5.30 at the I.E.E., Savoy Place, London, W.C.2.

**I.E.E. Cambridge.**—The chairman of the Radio Section of the Cambridge and District Group of the I.E.E., J. A. Ratcliffe, O.B.E., M.A., will address the first meeting of the Session on October 8th, at 6.0, at the Cambridge-shire Technical College, Collier Road, Cambridge. His subject will be "Radio from the Sun and the Stars."

**Radio S.E.A.C.**—The 100-kW Colombo broadcasting station of the South-East Asia Command, which, as mentioned in our last issue, is now radiating regularly in the 19-, 25- and 49-metre bands, is equipped with a Marconi Type TBS 801 transmitter.

**Television Society.**—An informal meeting will be held at the I.E.E., Savoy Place, London, W.C.2, on September 27th at 6.0.

**INDUSTRIAL NEWS**

**Radiomobile, Ltd.**, is a new company formed jointly by The Gramophone Co. and Smiths Motor Accessories for the design, manufacture and servicing of radio equipment for cars, with offices and works at Criclewood Works, London, N.W.2. Tel.: GLADstone 3333.

**Ekco Indoor Television Aerial**, designed to fit on the ceiling joists under the roof of a dwelling house, is a combination of three rod aerials, two

NOW IN PRODUCTION

**New IMPROVED 1946 Model**

**30-WATT AMPLIFIER T.633B**

Three stage, high gain type. Push-pull output circuit with inverse feed back. Embodying all the features responsible for the success and efficiency of the original T.633, with up-to-date refinements of design and finish. The new circuit provides facilities for speech/music switching or mixing to suit all conditions of operation.

Other Models available 5-500 watts and full range of accessories.



**TRIX**  
Quality  
**SOUND EQUIPMENT**

**THE TRIX ELECTRICAL CO. LTD.**  
1-3 MAPLE PLACE, TOTTERHAM COURT ROAD, LONDON, W.1  
TELEPHONE: MUSEUM 5917 GRANVILLE CABLES: TRIRADIO, WESDO, LONDON.

### World of Wireless—

horizontal and one vertical. The price is 30s and the makers are E. K. Cole, Ltd., Southend-on-Sea.

**Pye-Marconi.**—An agreement has been concluded between Marconi's Wireless Telegraph Co. and Pye, Ltd., covering the design, manufacture, and sale of a blind landing system for aircraft. Pye will, in technical collaboration with Marconi's, develop and manufacture the gear and the M.W.T. Co. will be responsible for its sale, installation and maintenance.

**G.E.C.**—The expansion of the G.E.C.'s radio factories during the war is graphically illustrated by a map in "G.E.C. Radio Engineering and the War Effort," a brochure which the company is distributing. In 1939 seven plants were wholly or partly concerned with radio production; in 1945 the total was 44, employing some 17,000 exclusively on radio.

**Cooper Manufacturing Co., "Lexington"** pick-up manufacturers, announces that in future all enquiries should be addressed to 17, 18 and 20, Hanway Street Works, Hanway St., London, W.1.

**Precision Components Co.,** of Aller, Langport, Somerset, advise us of a change of telephone number. It is now Langport 231. They also state that they are able to supply their Kabi 12-way, 15- and 30-amp terminal blocks cut into smaller units for a small extra charge.

### CLUBS

**Birmingham.**—A joint discussion meeting with the Model Aero Club on "Telearchics" has been arranged by Slade Radio for October 25th at 8.0 at its headquarters in Broomfield Road, Slade Road, Erdington. Hon. Sec., L. A. Griffiths, 47, Welwyndale Road, Sutton Coldfield, Birmingham.

**Bournemouth.**—The recently formed Bournemouth and District Amateur Radio Club, which has 40 members—14 of whom hold licences, meets on the second and last Tuesdays in each month at the Branksome Arms Hotel, Commercial Road, at 7.30. Hon. Sec., J. F. Squires, M.B.E., 80, Victoria Road, Bournemouth.

**West Hartlepool.**—Meetings are held fortnightly, on Thursdays, at 6, Musgrave Street, of the West Hartlepool and District Radio Club. Details of the club, which, after eight months' activity, has a membership of 25, including eight licensed amateurs, are obtainable from A. R. Donald, G3TO, 18, Stockton Road, West Hartlepool.

**Holloway.**—A regular weekly series of lectures covering the syllabus for the City and Guilds Amateur Radio Examination is included in the programme of the Grafton Radio Society, which meets on Mondays, Wednesdays and Fridays at 7.30 at the Grafton L.C.C. School, Eburne Road, Holloway, London, N.7. Hon. Sec., W. H. C. Jennings, G2AHB. Tel.: STAmford Hill 3891.

## OUTWARD FORM

Sets at the  
"Britain Can  
Make It"  
Exhibition

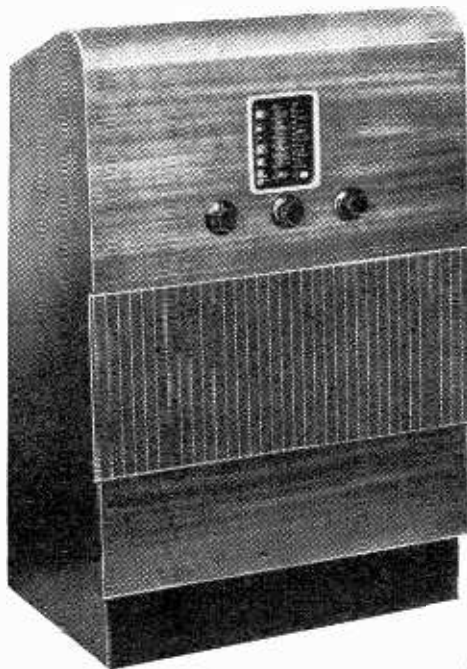

ward form," technical and constructional requirements were also taken into consideration, as was evidenced by the rejection of a set which, although externally very attrac-

The only console receiver at the exhibition—the Murphy U102C. Its radiogramophone and table counterparts are also on show.

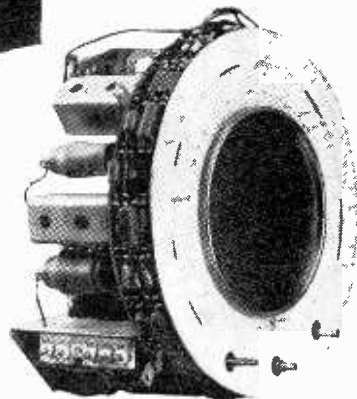

THE radio industry is represented by some twenty-five receivers at the "Britain Can Make It" exhibition which was opened by H.M. The King, at the Victoria and Albert Museum, South Kensington, London, on September 24th.

Some 130 sets were submitted by manufacturers for inclusion in the exhibition, which has been sponsored by the Council of Industrial Design.

Whilst the selection committee was primarily concerned with "out-

The accessibility of the components is a feature of the Ekco A22.



Murphy's Baffle Receiver in which the basic chassis member is a narrow steel shelf running the full length of the "cabinet."

tive, was functionally bad—the power equipment being so close to the roof of the cabinet that the veneered top would soon blister.

Can the ordinary broadcast receiver be made very different from the rectangular box with which we have become accustomed? At least two of the designs exhibited show a distinct break away.

The most strictly functional is perhaps the Murphy Baffle Receiver, Type A104. Instead of the usual

cabinet the chassis is mounted directly on to a baffle measuring 24 x 18 in, which is slightly curved in the vertical plane. Quality enthusiasts will appreciate the effectiveness of this form of construction. The depth of the set, which is supported by a strut at the rear, is only 6½ in.

Although the Ekco A22 receiver is housed in a circular plastic cabinet little different from its pre-

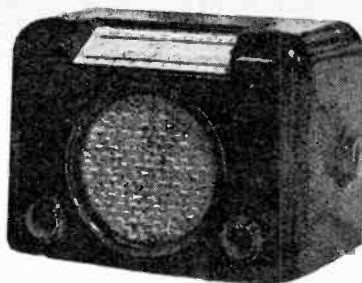
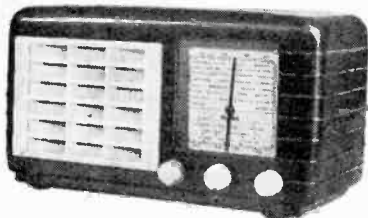

Examples of midget receivers in plastic cabinets. Above, the Bush DAC90, and, left, the Ultra U405. The Double Decca 46 portable is below.

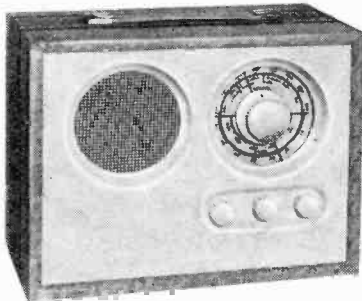

war predecessor, the fact that it is built on a circular chassis undoubtedly influenced its selection. The Perspex tuning scale of this three-valve (plus rect.) superhet surrounds the loud-speaker fret and has a calibration length of 2ft. A feature of this set, which covers the 16-50 metre bands in addition to the medium- and long-wave, is the ease with which it can be serviced.

There are a number of small

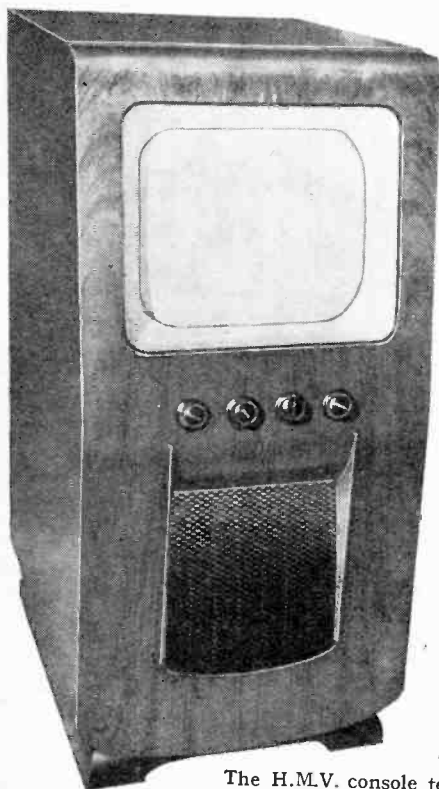

The H.M.V. console television receiver in which the upper portion of the cabinet is set at an angle.

receivers to be seen at the exhibition; for most of them plastics have been used for the cabinets. In the Ultra midget receiver, Type U405, the louvres of the loudspeaker fret partially conceal the grille. A sloping tuning scale on the front edge of the black plastic cabinet is a pleasing feature of the Bush DAC90, an A.C./D.C. 4-valve (plus rectifier) superhet which incorporates a built-in aerial.

Among the portables exhibited is the A.C./D.C./battery Double Decca 46 which is housed in a cabinet covered with "air travel" cloth. The controls are recessed in the white sprayed aluminium panel, thus reducing the overall depth. The self-contained frame aerial for medium- and long-wave reception is detachable for short-wave work.

Visitors will doubtless be disappointed to find only two television receivers exhibited in the radio and television section. One of these is a Marconi table model with a minimum of controls—two, and the other an H.M.V. console receiver with a 15in tube.

## THE NEW MULTITONE radio set FOR THE deaf

In 1933, we produced the first combined Wireless Set and Hearing Aid. Many of these are still in use. Our latest model is a powerful all-wave super-heterodyne. It is built in accordance with the latest developments in radio receiver design, coupled with our long experience in the manufacture of Hearing Aids.

The Radio Set for the Deaf is a unique instrument. It can be used by a deaf person either to listen in comfort to broadcast programmes from all parts of the world, or as a powerful hearing aid enabling the deaf person to join in the general conversation. In this latter capacity, it is certainly the most powerful instrument available anywhere. The instrument incorporates an "output limiter," the function of which is to protect the deaf person from sudden loud noises, thoughtless manipulation of the controls, or atmospheric. There is also a tone control, enabling the deaf person to vary the quality of reproduction to his or her individual requirements, and an independent volume control.

The deaf person has the choice of listening with a single earphone, double earphones, miniature ear-piece or bone-conductor. We recommend the use of double earphones, incorporating our patented Unmasked Hearing system, which gives a degree of intelligibility quite unobtainable with any other form of receiver.

### SPECIFICATION

8-valve super-heterodyne, with 5-watts push-pull pentode output.  
Delayed Automatic Volume Control on R.F. stages, together with Audio Frequency Automatic Volume Control on Hearing Aid.  
Variable Tone Control.  
Built-in Crystal Microphone.  
Cabinet, horizontal type, Figured Walnut, 24 ins. x 12 ins. x 10 ins.  
Mains voltages 110-250 volts A.C.  
3 Wave Bands:—Home and European Model—16-50 m., 200-550 m., 900-2,000 m. Overseas Model—13.5-38 m., 36-120 m., 200-550 m.

# MULTITONE

ELECTRIC COMPANY LIMITED

92 New Cavendish Street, London, W.1

C.R.C.104

# UNBIASED

By *FREE GRID*

## Transatlantic Menace

IN recent months, enough hot air has been generated in the House of Commons about the menace of sponsored programmes from the Continent to solve all Mr. Shinwell's fuel problems for several winters to come, and I am surprised that no member of the House has drawn his attention to it. It appears that the Government view any resumption of them with disfavour and so, for that matter, do I, if they are not going to rise above the soul-sickening sloppiness and sentimental slush which certain European stations dished out to us in pre-war days. But I do realize that there are others in the world apart from myself and the Government, which is perhaps a good thing, and if these slush fans enjoy wallowing in it, well, why shouldn't they do so, provided that they don't want me to do likewise and don't want to stop me indulging in my own pet perversions. There is room in the ether for all, provided that modern technique is adopted.

However, it is not about this particular aspect of the matter that I want to write. My purpose in drawing attention to it at all is to point out that while certain Members of Parliament on both sides of

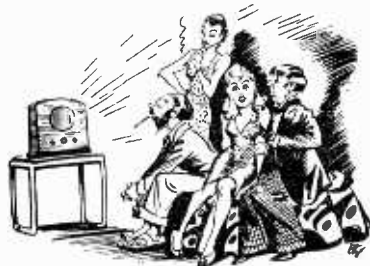

Slush fans

the House have been uttering pious platitudes about doing their best to discourage the renewal of sponsored programmes, preparations are being made by the Americans to swamp us with them, whether we like it or not, now that they have lent us a few dollars to spend with them. I may say that the confidential information which I possess comes from the very highest quarters in the U.S.A., namely, a correspondent who has his office on the top floor

of the Empire State building in New York.

According to him, the Americans realize that it is fairly useless directing S.W. programmes at us due to the inadequacy of the S.W. side of many British sets. They propose, therefore, to send over relays of planes to cruise just outside our territorial waters. Each plane will have a short-wave receiver in its tail to pick up the specially beamed and sponsored transmissions from the U.S.A. which will then be fed to a compact and efficient M.W. transmitter at the other end of the plane.

Quite frankly, I don't see what the Government can do about it. The situation will be somewhat analogous to that existing in 1923-1924 when the Americans made some very tart remarks to Whitehall about the number of British ships which were cruising up and down "Rum Row," a few miles outside American waters, waiting for their customers to come out in fast launches under cover of darkness. Our Government of the day expressed their regret and referred the whole matter to a select committee which is, I believe, still sitting on it, unaware that the Americans themselves eventually settled the matter by repealing the famous eighteenth amendment to the Constitution.

## Wireless for Weary Warriors

ACCORDING to reports the soldiers of the New Army are to be provided with separate bedrooms, reading lamps, h. and c., and all mod. con. of a type undreamt of even in the wildest extravaganzas of an Estate Agent's write-up man. No doubt the same privileges will be extended to sailors, both Naval and Mercantile. Such startling innovations would cause all the old sweats and shellbacks of my generation to turn in their graves—if any of them ever had the luxury of a grave in which to turn. So far as shellbacks are concerned, I speak with authority when I say that the only reading lamp they ever knew was a primitive contraption known as a slush lamp which hung in the midst of the foc's'le and emitted more smoke than light; this was perhaps all to the good as it pre-

vented too detailed a view of the weevils in the biscuits.

But enough of these musings. I took up my pen as I noticed that in the varied versions of the luxuries which may be provided in the private bedrooms of the warriors of the future no mention is made of the most essential luxury of all, namely, a bedside wireless set, to say nothing of television. There is no hint of even the barest bones of radio such as even hospitals provide, namely a pair of bedside headphones fed from a central receiver.



A pleasing programme

The omission of a radio set shows clearly how much the official mind is out of touch with the needs and desires of the average citizen from whose ranks the soldiers of the future will be drawn. I would hazard a guess that for every one citizen who takes up a book to while away the leisure hours there are a dozen who lean back in their armchairs and listen to Bach or Tommy Handley.

Apart from anything else, the radio is so much more an effortless amusement for the tired citizen or soldier than a book which has to be held up and its pages laboriously turned. Then, too, the weary warrior having got into bed with his book, may quickly find that it is not at all to his taste and he must either go to sleep in a thoroughly irritated state or put on his dressing gown and bedroom slippers and shuffle along to the regimental library to change the book. With a wireless set, an unfortunate choice of programme could be quickly remedied by the twirling of a knob or the summoning of an A.T.S. bedroom orderly to do the twirling.

Needless to say, I do not intend to let the matter rest until this glaring omission is rectified, for, as any modern youth will tell you, a radio set in the bedroom is worth any number of Field-Marshal's batons in the knapsack.



## LETTERS TO THE EDITOR

### Post Office "Dictatorship" ♦ Lamp Filament Failures ♦ "Tropicalized" Components

#### Receiving Licences

I HAVE just renewed my receiving licence and have been surprised by some of its provisions.

I note that I am authorized "to install and work apparatus for wireless telegraphy . . . for the purpose of receiving messages by telephony sent for general reception from authorized Broadcasting Stations or sent from authorized experimental stations in connection with experiments carried out by the Licensee" (my italics).

It would appear to be an offence to receive any morse transmission, or to listen to telephony from an amateur station unless one is co-operating with the sender in experimental work.

In view of certain statements by members of the Government it is pertinent to ask, "What constitutes an authorized Broadcasting Station?" Might it not become an offence to listen to a sponsored programme from a station abroad?

I may be reading more in the terms of the licence than is intended, but on the other hand it may well be the thin end of the wedge for controlling our listening, a Continental example of which we have already seen.

G. O. THACKER.

Warrington.

#### Why Pilot Lamps Burn Out

IN your September issue "Dial-list" has suggested that pilot lamps burn out because of the high current passed when the filament is cold. This is an oversimplification of the problem. If the filament were uniform, the high current would have no effect except that of speeding up the approach to the steady state. The current is reduced to its normal value when the filament reaches its normal working temperature, so that burning out by excessive current cannot occur.

A non-uniform filament, or a

circuit in which the pilot lamp is in series with similar filaments having a longer thermal time constant, is another matter. The low resistance of the second filament, or the colder portions of the non-uniform filament, will allow the application of an excessive voltage to the portion of filament under consideration and will produce a hot-spot.

The use of lamps having short, thick filaments, connected directly to a suitable transformer winding, should give satisfactory service. Only too often, I suspect, a 4.5 volt lamp is used in a 6.3 volt circuit. My own receiver retains its original seven-year-old lamps in full working order.

THOMAS RODDAM.

#### Impregnated Windings

IN your September issue O. P. Scarff offers an interesting explanation for the failure of so many efforts at "tropicalizing" transformers and chokes. His description of the mechanism of moisture ingress confirms the conclusion derived from wartime experience that 100 per cent protection is obtained only by enclosing the component in a hermetically sealed container with the remaining space occupied by clean, dry air, oil, wax or other suitable filling in accordance with design requirements. Although many use the term rather loosely, hermetic sealing strictly implies an impervious enclosure having no cracks or channels which are wider than the order of intermolecular spacing. Thus where lead-out connections pass through insulating material the metal must be "wetted," in the physics sense, by the insulant, as with "Covar" glass or ceramic seals, but not with metal inserts in plastic mouldings.

With regard to other processes of tropicalization such as vacuum impregnation, etc., Mr. Scarff makes the point that the better the process the finer the cracks

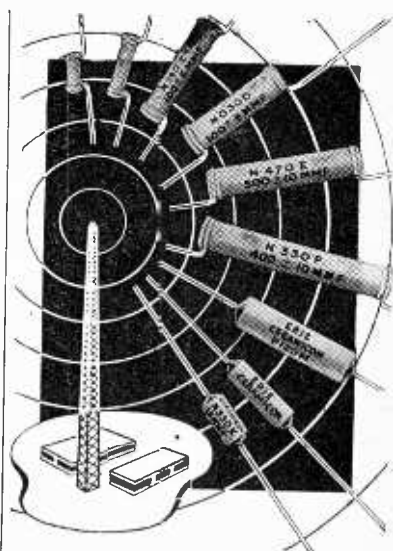

**ERIE** Ceramicon

**MAINTAIN SUPREMACY  
IN THE FIELD OF COMMUNICATIONS  
FOR TEMPERATURE COMPENSATING  
& GENERAL PURPOSE CONDENSERS**

STYLE	CAPACITY RANGE		
	P080 P100 P120	N750	HI-K
A and K	MMF 1-9	MMF 1-51	MMF 56-560
B and L	10-18	52-110	560-1,500
C and M	19-63	111-360	1,500-4,700
D	64-93	361-510	4,700-6,800
E	94-150	511-820	6,800-12,000
F	151-200	821-1,100	12,000-15,000
G	—	—	15,000-22,000
H	—	—	22,000-33,000

Tolerance on Temperature Co-efficient is—  
30 parts/million/°C or ±15%, whichever is the greater.

Note: Styles A, B, C, D, E, F, G and H are non-insulated units. Styles K, L, and M are insulated.

**MAY WE SEND YOU SAMPLES  
FOR TEST OR FOR PROTOTYPES?**

**ERIE RESISTOR LIMITED**

CARLISLE RD. • THE HYDE • HENDON  
LONDON • N.W.9  
TELEPHONE: COLINDALE 8011  
FACTORIES: LONDON • ENGLAND  
TORONTO • CANADA • ERIE, PA. • U.S.A.

(e.g., between copper and insulation) through which water in preference to air would be driven by the high pressures of osmosis. This water would be trapped and with the normal heating and cooling cycles of operation the process is cumulative. Eventually the insulation would be ruptured.

Impregnated transformers and chokes used in temperate climates would be liable to the same trouble. Mr. Scarff makes a good case for the adoption of a more open type of construction so that any moisture finding ingress can be just as easily driven out again by the normal heating during operation. Such an open construction, provided that only the very best insulating materials such as acid-free paper are used, has proved very satisfactory in practice. It is true that failures occasionally have occurred mainly with the finest gauges of wire carrying DC, but these failures can usually be traced to the component having been stored or operated in an acid-polluted atmosphere. In such locations a special sealed component is obviously necessary.

The argument for an open construction can be applied against any unventilated cans or fancy shrouds which do not prevent moisture getting in but which do restrict the rapid evaporation of such moisture by the normal warmth generated during service. Sometimes these shrouds serve only to conceal dubious material or rough workmanship.

TREFOR WILLIAMS.

Partridge Transformers, Ltd.,  
London, S.W.1.

IF moisture gains an entry to a component it will not only lower insulation resistance, but it will have a chemical effect, such as the oxidation of metals, the hydration of organic insulating materials, the deposition of dissolved salts or by supporting mould growth, and a secondary effect arising from corrosion set up by electrolysis. While open construction will enable rapid drying to take place on switching on the power to the component, it does not follow that components will all develop sufficient heat to dry themselves out, and in any case such a construction

suffers from the defect that chemical deterioration of the article can take place during the quiescent period or during storage.

Thus hermetic sealing is essential for tropical situations and very desirable for all other locations. While not absolutely necessary for our temperate climate, where condensation is quite common, some sealing is essential.

A suitable process widely used on transformers is to impregnate with wax or some suitable compound in order to fill voids, etc., and then to seal this with one or more dip coats of varnish, wax or bitumen with the purpose of sealing off those minute channels to which Mr. Scarff refers.

R. BURKETT.

Welwyn Electrical Laboratories, Ltd.,  
Welwyn Garden City.

### Speaker Prices

IT is difficult to fathom the reason for the high prices charged for 12in and 15in moving-coil speakers when the workmanship and material is compared with a present-day radio receiver.

It should be realized that buyers of such speakers have a good idea of what is a fair price and fair profit for radio equipment.

C. L. AGER.

Southall Park, Middx.

### "Television V.F. Stage"

I WAS very interested to read W. T. Cocking's article in your August issue, since he describes an arrangement patented by Ferranti, Ltd., M. K. Taylor and W. Wood in 1938 (B.P. No. 494,502).

Though Mr. Cocking gives an excellent statement of the pros and cons of C.R.T. cathode modulation, I should like to make the following comments:

(1) No mention is made of a very useful feature of the arrangement, namely, that during the "warming-up" period of the receiver it ensures that the negative grid-to-cathode bias on C.R.T. is excessive and therefore no bright spot can burn the screen before the time bases come into operation.

(2) The use of cathode de-

generation in the V.F. stage is unfortunate since it reduces the stage gain (to quote Mr. Cocking's figure) to 2.88. The full stage gain of 15 can be obtained if a negative bias supply is available for the grid circuit of the V.F. amplifier.

(3) A disadvantage of the arrangement is that it increases the shunt capacity across the anode load of the video stage as the sync separator input is connected to the video anode. [Surely this disadvantage applies to all circuits, and not only to the one under discussion. The sync separator must be fed from somewhere!—Ed.]

(4) It is true that the arrangement gives the more convenient polarity for sync separation, but it should be noted that the inevitable non-linearities in both detector and video amplifier stages are both in the same sense and result in a picture-to-sync ratio, at the video anode, which is considerably greater than 2:1, a consideration which must be taken into account when deciding the optimum length for the sync separator grid-base.

(5) The maximum positive DC potential on the cathode of the C.R.T. is likely to be 300 volts or more (during the "warming-up" period), and on this account the C.R.T. must have very good heater-to-cathode insulation or, alternatively, its filament must be fed from a separate L.T. winding connected through a high resistance to a point at a suitable positive potential (e.g., to the C.R.T. cathode itself).

(6) Adjustment of the vision gain control alters the "black level" of the picture, which must be restored by adjustment of the brightness control potentiometer. This disadvantage may be substantially eliminated by an automatic compensation such as that described in Patent No. 515,426, whereby the change in anode current to one or more pre-detector stages consequent upon a change in gain control setting is utilized to derive a compensating potential applied to the grid of the C.R.T.

Ferranti, Ltd., H. WOOD.  
Moston, Lancs.

# SHORT-WAVE CONDITIONS

## Expectations for October

By T. W. BENNINGTON

(Engineering Division, B.B.C.)

THE daytime maximum usable frequencies for this latitude during August were about the same as during July, while the night-time M.U.F.s were considerably lower than during that month.

Long-distance communication on exceptionally high frequencies—like the 28-Mc/s amateur band—was infrequent to countries in the Northern Hemisphere, a situation which should alter during September. Sporadic E was still of frequent occurrence and often allowed high-frequency communication to medium distances.

There was relatively little ionosphere storminess during the month, and, apart from a few days of slightly deteriorated conditions, storms only occurred on 11th, 14th-16th, and 27th. A few "Dellinger" fadeouts occurred, notably on 2nd and 23rd.

**Forecast.**—During October the daytime M.U.F.s for most paths should continue to increase, the seasonal and solar cycle effects both contributing to this result. As will be seen from the tables of predicted working frequencies given below this increase will in most cases be very considerable, and long-distance communication by way of the F<sub>1</sub>F<sub>2</sub> layers will be possible on exceptionally high frequencies. DX work on the 28-Mc/s amateur band should, for example, be frequently possible to most parts of the world, and M.U.F.s may well rise above 40 Mc/s on certain routes on isolated days.

Night-time working frequencies are expected to decrease somewhat as compared with September, though the use of bands much below 9 Mc/s will not often be necessary.

Sporadic E is not likely to be much in evidence, and the normal E layer will not control transmission for any distance in these latitudes. Mention of these two phenomena in this column will now be discontinued until they become of importance again; i.e., in the early summer of next year.

Below are given, in terms of the broadcast bands, the working frequencies which should be regularly usable during October for four long-distance circuits running in different directions from this country. In addition, a figure in brackets is given which indicates the highest frequency likely to be usable for about 25 per cent of the time during the month for communication by

way of the regular layers (times in G.M.T.)

<b>Montreal :</b>	0000	11 Mc/s	(15 Mc/s)	
	0200	9 "	(13 "	
	0900	11 "	or (18 "	
		15 "	" "	
	1100	15 "	or (24 "	
		17 "	" "	
	1200	21 "	(30 "	
	1500	26 "	(33 "	
	1700	21 "	(30 "	
	2000	17 "	or (24 "	
	15 "	" "		
2200	11 "	(16 "		
<b>Buenos Aires:</b>	0000	11 Mc/s	(16 Mc/s)	
	0200	9 "	(15 "	
	0600	11 "	or (17 "	
		15 "	" "	
	0900	17 "	(24 "	
	1000	21 "	(32 "	
	1100	26 "	(38 "	
	1900	21 "	or (31 "	
		17 "	" "	
	2100	15 "	(21 "	
2200	11 "	(17 "		
<b>Cape Town :</b>	0000	11 Mc/s	(16 Mc/s)	
	0600	17 "	(25 "	
	0700	21 "	(36 "	
	0800	26 "	(39 "	
	1800	21 "	(32 "	
	1900	17 "	(26 "	
	2000	15 "	(22 "	
	2100	11 "	(18 "	
	<b>Chungking :</b>	0000	9 Mc/s	(14 Mc/s)
		0400	11 "	or (17 "
		15 "	" "	
0600		17 "	(22 "	
0700		21 "	(31 "	
1200		17 "	(26 "	
1300		15 "	(23 "	
1500		11 "	(17 "	
1900		9 "	(15 "	

During October ionosphere storms are often prevalent and periods of poor communication are therefore to be expected. At the time of writing it would appear that such disturbances are more likely to occur within the period 4th-5th, 7th-10th, 17th-19th and 27th-28th than on the other days of the month.

**Footnote** :—I have been asked to explain why it is necessary to use short waves for local broadcasting in certain parts of the world. This is the case in tropical countries and is occasioned by the fact that, because these countries lie in or near the world's main thunderstorm producing areas and consequently within the range of the ground waves of very frequent lightning strokes, the noise level on medium waves is so high and the required field intensity for good reception is consequently so great, that efficient coverage is impossible of attainment on these wavelengths. On short waves the radio noise and required field intensity is much lower. The longer short waves must be used because it is necessary to work only just below the vertical incidence critical frequency in order to ensure that there is no skip zone. In the temperate zones these considerations do not apply.

## ONE LOUDSPEAKER —360° COVERAGE

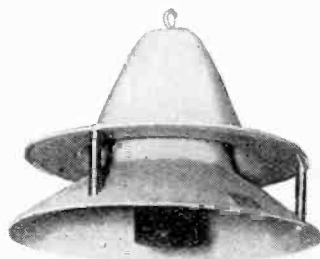

This new type, called the CIRCORN, has horn-speaker efficiency together with completely uniform distribution throughout 360 deg.

Typical advantages :—ONE centrally placed will cover the whole of a medium-sized area ; used on a moving vehicle results are equal approaching, passing or receding, thus ideal for street processions, elections, etc.

List price—Horn only £7 0 0.  
Complete £14 5 0.



M.5  
Moving Coil  
MICROPHONE

No polarising current, adequate frequency response, low impedance, high output due to a very efficient magnet and careful design.  
List price £5 15 0.

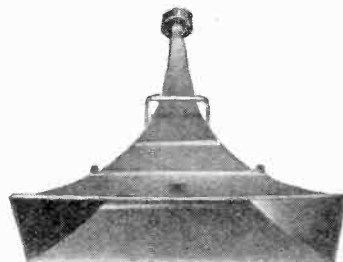

L.S.7 HORN LOUDSPEAKER  
Maximum sensitivity and volume. Impedance 10 ohms ; handles 2 watts 170-10,000 c.p.s., 40 in. horn. List price £13 10 0.

**F.I. for P.A.**  
**FILM INDUSTRIES LTD.**  
60, PADDINGTON ST., W.1  
Telephone WELbeck 2385

# RANDOM RADIATIONS

## Horizontal v. Vertical

ONE outstanding result of the B.B.C.'s field trials of A.M. and F.M. is the complete vindication of the belief that on the ultra-short waves horizontal polarization would be superior to vertical in the matter of freedom from man-made interference. Prior to these trials no data based on actual measurements had been compiled. Even in the United States, where research by the concerns interested in U.S.W. broadcasting was not suspended until their country's entry into the war at the end of 1941 after Pearl Harbour, no real facts were available. There was a general belief amongst experts that vertical polarization would eventually prove to be superior to horizontal, but that was as far as it went. The B.B.C. research department has clinched the matter by giving the world for the first time the co-ordinated results of practical tests and precise measurements. The tests were (and still are) conducted on frequencies of the order of both 45 Mc/s and 90 Mc/s. They show beyond any shadow of a doubt that horizontal polarization is vastly the better. On 45 Mc/s the worst type of interference is that from motor-car ignition systems; on 90 Mc/s it is the only kind of interference that is of any real importance. At either frequency the field strength necessary to override such interference is far smaller with horizontal than with vertical polarization. Another result of the trials is the refutation of the contention that one has often heard expressed: "On the U.S.W. A.M. can do everything possible with F.M., without needing anything like such a fantastic band of frequencies." The trials show that A.M. is a long way behind F.M. as a medium for high-fidelity, interference-free broadcasting on the U.S.W.

## The Pity On't

Interference from car ignition systems being the menace that it is and is likely to remain for some time, it is rather sad that vertical polarization should have been adopted for both sound and vision in our existing and projected television broadcasting schemes. At the time when the Alexandra Palace station was erected (1935, wasn't it?) no one knew very much about the respective merits of the two kinds of polarization in the way of freedom from interference. That being so, a decision was not unnaturally made to adopt vertical

By

## "DIALLIST"

polarization, since it makes the transmitting aerial problem so much simpler. The service area of a transmitter should ideally be circular in shape and there is no great difficulty about obtaining an approximation to this with a vertical half-wave dipole array: over a level homogeneous surface the azimuthal polar diagram of a single vertical half-wave dipole is circular. But the horizontal half-wave dipole under the same conditions has a figure-of-eight polar diagram, and to obtain an approximately circular service area from an array of these would present greater difficulties in both design and installation. Still, if we had known as much then as we do now about the influence of polarization on freedom from man-made interference, we should undoubtedly have plumped for the horizontal method, with great benefit to television reception. It is too late to change now; but it is certainly not too late to strike at the root of the evil by making the fitting of suppressors to ignition systems compulsory.

□ □ □

## Labour Charges

IT was good to see the question of labour charges made for the "free replacement" of faulty components under the three months' receiving set guarantee referred to in the Editorial of last month's *Wireless World*. There are firms who interpret the labour-charge clause liberally, but, in the past at any rate, there have been others whose interpretation was far from being anything of the kind. Personally, I regard that clause as more than regrettable and would welcome its abolition. Free replacement of a faulty part should mean its replacement in the set free of all charge to the owner. To my certain knowledge it is a definite brake on the sales of the larger radio sets and a still more effective one on those of television receivers. Manufacturers are too apt to forget that one customer who has had what he feels to be a raw deal may undo the work of much costly advertising by recounting his woes to all and sundry. And there are raw deals. Let me give two instances for which I can vouch. Case No. 1: The pur-

chaser had a 25-cycle mains supply and paid an extra guinea for a suitable model. Within 14 days the set was out of action, and examination by the vendor disclosed a burnt-out mains transformer. The set was returned to the makers and the following invoice was received by the purchaser:

	£	s.	d.
Free replacement of faulty transformer..	0	0	0
Dismantling set, fitting new component, reassembling, cleaning and very carefully testing ..	1	17	6
Carriage one way ....	4	6	
	£2	2	0

This worked out at 12½ per cent of the cost price of the set. It is difficult to see why, if there is a guarantee, the purchaser should be asked to pay such a sum simply because the makers in the first instance supplied a component that was not up to the work. And can you believe, in view of the staggering labour charge, that the makers were one penny out of pocket in making the alleged free replacement? Case No. 2: Within six weeks of the installation of a receiver an electrolytic "blew up," wrecking a couple of valves. Free replacement of the condenser cost £1 2s 6d in labour charges and the owner was presented also with a bill for two new valves, a further £1 5s or so. When he protested about the latter charge, the set-makers referred him to the valve makers, the valves being covered by a separate guarantee. Not unnaturally, the valve makers repudiated responsibility, since the disaster was due to no fault in their wares.

## A Suggestion

In both the instances given the makers did what they undertook to do; nor did they take anything that they were not entitled to take under the guarantee. But did either purchaser receive treatment that would leave him satisfied that he had been fairly done by? Each had bought a set which broke down after a small amount of use owing to the presence in it of a "dud" component. They believed themselves protected by the guarantee, but found that a manufacturing defect, admitted by the makers, left each of them more than a couple of pounds out of pocket. That sort of thing is all wrong, and it may be a much more expensive business to obliterate "bad will" than to build

up goodwill. I am sure that if the makers gave a cast-iron guarantee to set right absolutely free of charge any defect that occurred within three months—I would prefer six months—the result would be spectacular. At the moment radio sets have a sellers' market; but even so the demand has not quite come up to the slap happy expectations of the immediate post-war period. There won't always be a sellers' market, but there should be a good and steady market if the potential buyer feels that he can rely on what is offered to him. I have no doubt at all that a guarantee of the kind suggested would pay handsomely, since it would promote confidence. In offering it makers should, after all, be taking no great chances, provided that their test departments are all that they should be. The rental companies don't make excessive hire charges, but they mostly show good profits, and their success is largely due to the confidence inspired by the all-in guarantee that they give.

□ □ □

#### Printed "Wiring"

AN interesting method of making radio set connections without wires—of producing, in a word, real wire-less apparatus—has been developed in America. The connections are printed on the panels, the "ink" being a solution of silver, which is dried, baked on and finally varnished over. Both sides of the very thin panels are used, which makes it easy for two leads to cross one another. A small hole is drilled in the panel on either side of the lead that is to be crossed. The crossing lead is printed on the underside of the panel as far as the holes and between them on the upper side. Later the holes are filled with silver solution by means of a fine paint brush. The process is said to be quick and cheap. All the holes are drilled simultaneously by means of a jig and the entire wiring is done in one operation in the printing press. It is stated that even the resistors are printed by the use of appropriate solutions. Small fixed capacitors can be produced by a rather more elaborate process: one "plate" of each is formed at the first printing; a second printing applies the dielectrics and another the second "plates."

#### "Electromagnetic Frame Scanning"

In the article on p. 289 of the last issue, capital sigma ( $\Sigma$ ) was used in error instead of epsilon ( $\epsilon$ ) in the exponential expressions giving the rate of change of current in the circuit.

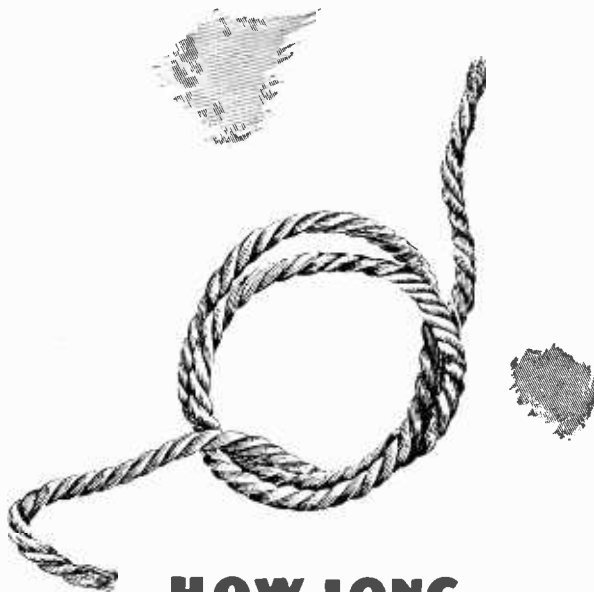

## HOW LONG

*is a Piece of String?*

There is no answer. Or you may argue it is the exact footage of the string you do in fact possess.

It's the things you actually possess that matter, not things in the vague future. With Bulgin it is the labour and materials *now available* that count. They govern our production and supplies of components.

If we sacrificed quality for quantity, production would go up and our reputation would go down. That is a course we would never pursue. Bulgin quality will always be there. Sooner than you think, the quantity you need will be there also.

# BULGIN

*Famous since Broadcasting Began*

A. F. BULGIN & CO., LTD.

BYE PASS ROAD - BARKING - ESSEX

RIPpleway 3474 (5 lines)

# RECENT INVENTIONS

## U.H.F. TRANSFORMER

FOR centimetre waves, the arrangement shown in diagram (a) simulates the three-coil transformer shown in diagram (b).

The chamber R is fitted with one or more tuning-bars T, and oscillates as a half-wave resonator. It is coupled to two coaxial lines C, C<sub>1</sub>, one as an input and the other as output. The inner and outer conductors of each line are inter-coupled by the series capa-

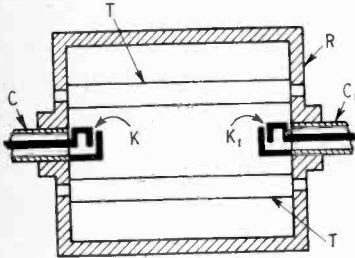

(a)

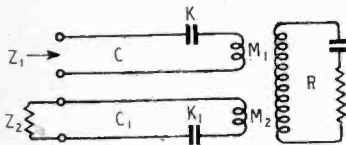

(b)

Cavity transformer and equivalent circuit.

citances K, K<sub>1</sub> between the end flanges and loops; this coupling is fixed, in the case of the input, and is adjusted to a given value, in the case of the output line, before they are inserted in the resonator. The coupling, corresponding to M<sub>1</sub>, M<sub>2</sub>, diagram (b), between each line and the resonator, depends in part upon the length of insertion, and in part upon the orientation of the looped ends to the bars T.

Matching or transformation of the impedances Z<sub>1</sub>, Z<sub>2</sub>, diagram (b), can be effected by adjusting the different variables. By inserting a fixed resistance in one of the lines, any desired value of attenuation can be introduced into the other line.

J. Collard. *Application date, June 3rd, 1941. No. 573365.*

## RADIO COURSE INDICATORS

IN a guiding system of the kind in which two overlapping beams are modulated with interlocking signals, positive "dot" or "dash" signals are received only when the craft deviates to port or starboard, respectively, the median-line or true course being indicated negatively, i.e., by the absence of signals. Any breakdown in the system may therefore leave the pilot under the false impression that he is still "on course."

As a safeguard, provision is made for

## A Selection

### of the More Interesting Radio Developments

giving a positive indication of any failure in the system. A neon lamp, for instance, is shunted across the anode resistance of one of the R.F. amplifiers, which is so biased that the lamp will only glow so long as beam signals are being received. By suitably adjusting the bias, the lamp may also serve as a "marker" in a blind landing system; it then "strikes" at the beginning and "quenches" at the end of the gliding path.

Standard Telephones and Cables; C. W. Earp; and J. D. Weston. *Application date, January 20th, 1944. No. 574340.*

## SOUND PROJECTION

THE horn of a loudspeaker L is backed by a reflector S which forms part of an ellipse E, having one focus F<sub>2</sub> at the virtual source of the sound, and its other focus at F<sub>1</sub>. In effect the source is thus transferred to F<sub>1</sub>, and the reflector S gives a coverage represented by the angle A. A second loudspeaker L<sub>1</sub> is similarly backed by a reflector S<sub>1</sub>, which forms part of an ellipse having foci at F'<sub>2</sub> and F'<sub>1</sub>, and giving a coverage shown by the angle B.

By a suitable choice of the ellipse on which the reflector is based, the normal coverage of a horned loudspeaker can be increased, or decreased and concentrated in a desired direction. In a particular application, two folded horns are united by two elliptical

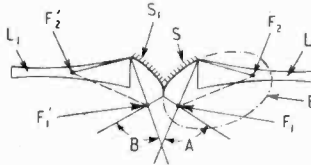

Wide-angle sound source.

reflectors, which are located at the common "fold," and focus both the virtual sources of sound into a common flared mouth.

Western Electric Co., Inc. *Convention date (U.S.A.), December 30th, 1942. No. 574370.*

## TELEVISION RECEIVERS

IF the scanning beam of a C.R. tube is projected at high speed against a very thin metallic film, the picture can be made visible by incandescence, but the conversion efficiency of such a system is admittedly low.

It is now proposed to utilize the heating effect of the scanning beam to

alter the prevailing transparency of a suitable target-screen, which is illuminated by a constant source of light, so that the picture is projected on to an external viewing-screen. Various materials, including aluminium oxide, and glass tinted by iron and manganese oxides, are stated to show the desired variation of light transmission when subjected to comparatively small changes of temperature.

As shown, the action of the scanning-beam produces local heating of the modulating target T. The resulting transient changes in transparency are sufficient, when illuminated by the

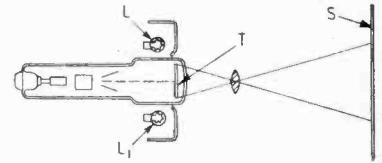

Variable transparency screen.

shielded lamps L, L<sub>1</sub>, to project the resulting picture on the external screen S.

G. Liebmann and Cathodeon, Ltd. *Application date, November 20th, 1941. No. 575060.*

## SHIP INSTALLATIONS

THE radio transmitter of a ship is coupled to an auxiliary microphone and loudspeaker system through an audio-frequency amplifier which is common to both installations. The auxiliary microphone is preferably located on the bridge, and is shunted across the transmitter keying circuit by a press-button switch. A second switch couples the A.F. amplifier output either to the modulator or to the loudspeaker as required; in the latter case, it breaks the H.T. supply to the R.F. stages.

The arrangement is particularly useful for communication between ships in convoy, or during rescue work, because it allows a quick change-over to radio signalling when the normal hailing distance is exceeded. By sending morse signals through the loudspeaker the aural range can be increased when the use of radiated messages is undesirable, owing to the presence of enemy craft.

International Marine Radio Co., Ltd., and C. G. G. Withey. *Application date February 21st, 1944. No. 572783.*

The British abstracts published here are prepared with the permission of the Controller of H.M. Stationery Office, from specifications obtainable at the Patent Office, 25, Southampton Buildings, London, W.C.2, price 1/- each.

This, in the field  
of physics,  
is the symbol for

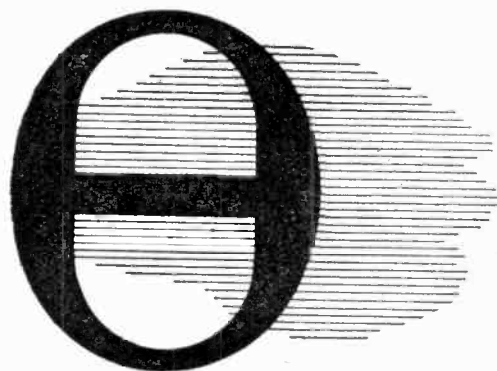

**absolute temperature**

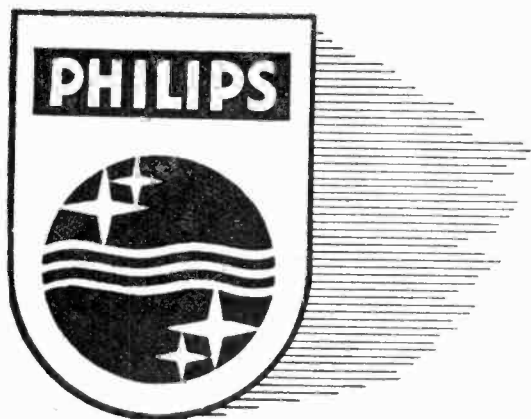

This, in the field of  
electrical products,  
is the symbol for

**absolute dependability**

**PHILIPS**

LAMPS RADIO X-RAY COMMUNICATIONS EQUIPMENT

AND ALLIED ELECTRICAL PRODUCTS

PHILIPS LAMPS LTD. CENTURY HOUSE, SHAFTESBURY AVENUE, LONDON, W.C.2.

(1481)

Rate 6/- for 2 lines or less and 3/- or every additional line or part thereof, for 4 or more lines 5-6 words. Box Numbers 2 words plus 1/- Press Day - November 1946 issue, first post Wednesday October 9th. No responsibility accepted for errors.

**WARNING**

Readers are warned that Government surplus components which may be offered for sale through our columns carry no manufacturer's guarantee. Many of these components will have been designed for special purposes making them unsuitable for civilian use, or may have deteriorated as a result of the conditions under which they have been stored. We cannot undertake to deal with any complaints regarding any such components purchased.

**NEW RECEIVERS AND AMPLIFIERS**  
NEW Corsor double beam oscilloscope; £45 or nearest or exchange Avo R. & C. tester and cash adjustment.—Box 1791. [5846

**H**IGH quality all-wave 5-valve superhet kits, ac model, 15gns; Aldry portable, 12gns.—Radio Diagram & Supply, 16, Woodlands Rd., Romford, Essex. [5875

**K**ITS.—Quality amplifier push-pull output, neg. feed back, independent, treble and bass, also ac/dc, station named dial, delivered complete to last nut, full wiring in instructions; price £7/8, c.w.o. or c.o.d.—Isher woods, 81, Plungington Rd., Preston, Lancs Tel. 3348 Preston. Radio repairs est. 1936

**B**AKER'S.—New 7-valve "Wireless World" Quality amplifier with tone control stage. 8 watts push-pull triode output, price includes super Quality triple cone, 12in permanent magnet speaker, with large output transformer and all valves; also as above but with 15 watts tetraode output, ideal for realistic reproduction for public address; 2 1/4d. stamp for parties., prices, etc.—Bakers Selhurst Radio, 75, Sussex Rd., S. Croydon. Croydon 4226.

**S**PECIAL offer, while they last.—New 1946 25-watt ac high fidelity amplifiers, realistic reproduction, complete with valves, ready for use. £8/19/6; with mike stage, and special bass and treble control circuit, £10/15/6; carriage and packing 5/- extra. NEW 1946 factory built ac/dc 5-valve superhet. receiver in full size, dual toned, beautifully finished cabinet, 8in speaker, £17; carriage and packing 15/- extra, 10/- refunded on return of case

**R**ADIO kits.—5-valve ac/dc 3-wave superhet kit, complete, including valves and 6 1/2in speaker nothing more to buy; £12/5.

**T.R.F.** 4-valve ac/dc medium and long wave kit, complete, 6 1/2in speaker. £8/19/6; only new high grade components used; no Government surplus parts; terms: c.w.o.—A.E.C. Radio, 9, Larbreck Ave., Blackpool, Lancs.

**A**MPLIFIERS.—New De Witt 1946 amplifiers, 20 and 30 watt models with the new HiFidelity tone control circuit, prices from £7/19/6 to 10gns. complete, ready for use, six different models to choose from, superb performance, amazing value; send s.a.c. for illustrated catalogue and price list; trade terms available.—Obtainable from British Radio Co., 410, Dudley Rd., Edgbaston, Birmingham. Willingly demonstrated to callers. Hundreds of satisfied users have sent highest testimonials.

**E**XCEPTIONALLY high fidelity amplifiers incorporating the new cathode follower output circuit and flexible bass and treble tone control, now available for home constructors; to music lovers these amplifiers set a new high standard of reproduction; 7watt and 3watt amplifiers and radio tuner unit; full drawings and point-to-point wiring diagrams 2/6 each, 5/- the set of three; separate components or complete kits of parts for all units available, including ready drilled chassis. Send stamp for details and price lists. All types of components available c.o.d.—Send your requirements (post only) to Charles Amplifiers, 14 Tapstone Gardens Kenton, Middlesex.

**Partridge News**

**INDIVIDUAL DESIGN**

PARTRIDGE Precision Built TRANSFORMERS would suit individual requirements now incorporate:—

Silver plated turret terminals giving a low potential drop and carrying up to 15 amps. Adequate room on each for easy soldering of several external circuit wires.

Firm clamping of the laminations by means of scientifically designed pressure die-castings.

Interlocked fixing feet providing alternative mounting.

**AVAILABLE STOCK**

A comprehensive range of mains and audio components is now available from stock, and we can despatch small quantities of these per return. We would stress that before ordering you send for our list detailing these components. Our stock range now covers almost all normal requirements, and by availing yourself of this service you will save the inevitable delay in the production of a special component. We shall be pleased to send you our stock list upon receipt of your address.

Telephone:



Abbey 2244

**PARTRIDGE TRANSFORMERS LTD**

76-8, PETTY FRANCE, LONDON, S.W.1

New Models of Radio Cabinets

The time is very near when we shall be able to release details of our first post-war models. These will incorporate many new features. Our policy has been that rather than produce an article falling short of our pre-war quality, we would defer manufacture until we could once again make Radio Cabinets up to our usual high quality standard. This we hope to be able to do in a month or two.

Under present clerical staff difficulties it is not possible to acknowledge enquiries, other than those holding licences but all names and addresses will be entered on our waiting list, and literature will be sent when available



67, Lowlands Road, Harrow, Mdx.

Phone: BYRon 3704

**C**OMMUNICATIONS 7-valve Superhet with built-in speaker and B.F.O., all ham bands, world wide reception, callers only; £21/10.—Whitton Electrical, 46, Hounslow Rd., Whitton, Middx. Hou. 3622. [5820

**R**ECEIVERS, AMPLIFIERS—SECOND-HAND PRESELECTION using two Accoras; £10.—James, 72, Kimberley Rd., Croydon. [5821

**14** WATT quality amplifier, as new; £10.—McKean, 150, Dorchester Av., Glasgow.

**H**ALLICRAFTERS, SX28, and speaker, absolutely as new, used very little; what offers?—Box 1882. [5880

**N**ATIONAL senior HRO 6.3-volt 50kcs to 30mc, spare valves, unused, £40; 6-volt vibrapack for above, £5.—Box 1984. [5914

**N**EW Scott Phantom, 16 valves, superhet ac mains, 4 wavebands, 12in speaker, output 13.5 watts, veneered walnut console, overhauled perfect; nearest £100.—Box 1673. [5881

**R**.A.F. 1155A, modified, with power pack, R sprk., phones, £28; 8-valve commercial relay rec., coverage 150kc to 21mc/s, £18.—Gasoline, 23, Nottingham Place, W.I. [5864

**M**ARCONI CR100 Rf. 2r 3if B.F.O., Xtal filter, S meter, N silencer 60 kc to 30 mc cont., ac or batt. operation, circuit, etc., cost £90, sell £50.—Box 1854. [5868

**T**ELEFUNKEN "Super" D760 WK 3-band push-button receiver, superb performance, unexcelled response, almost new, passed by Customs; 38gns.—Murphy, 14, Rosebery Gardens, W.13, Perivale 2414. [5823

**H**.M.V. 1940 lab model, 6v plus, m/eye, ac, push-button motor-tuning, 2 s/w bands, elec spread, table model, massive walnut, as new; viewed evenings W. London, 15gns.—Write Box 2281. [5946

**H**ALLICRAFTER 10-valve ac Ultra S.W. communication receiver, 3.75 to 53 metres, in four bands, A.V.C., B.F.O., Xtal, etc.; offers or exchange for all-wave communication rec.; cash either way.—BM/GBK, W.C.1. [5869

**W**.W. quality amplifier and receiver, matched with 12in Goodmans (new) and Colorado electric turntable with piezo brush p.u., complete and in perfect working order; best offer over £30 to W. D. Hodgson, Harwood Lane, Northallerton, W. 12. [5906

**C**OMMUNICATION receiver, 9-valve, 12 dc, 110-250 ac, 5 band, 1.5-25 mc/s, set of spare valves, B.F.O. and V.C. control, housed in steel cabinet, a beautiful piece of precision electrical and mechanical engineering in perfect order; offers over £30.—Box 1668. [5817

**R**.1155 R.A.F. receivers as described in *Wireless World*, July, excellent condition, £15; can be supplied modified for civilian use, receivers already purchased expertly modified to your requirements, and amplifier/power packs supplied.—R.T.S., Ltd., 8, Cadstones Rd., Wimbledon, S.W.19. Tel. 3303. [5659

**F**OUR-BAND transmitter "Wireless World," 13d, July, 1939, 7, 14, 28.56 mc/s 30 watts, completely new, never used, valves, coils, crystal and mike, rack mounting panels, separate power units for modulator and RF unit, Partridge transformers, Brooks crystal, B. and M. mike, all finest components; £85 complete.

**H**ALLICRAFTER 5/10, ac 110 or 230, 2 bands, 25/40 and 38/66 mc/s, condition 100%; offers.

**C**OLLARD auto changer with magnetic pickup, brand new, in storage; offers; numerous other items, please enquire.—Box 1981.

**S**PECIAL Super-Skyrider Hallicrafters SX-17, 13 tube, 6 band, 545 kc, 62mc, Xtal, noise silencer, S. meter, all communication features, 12in Hallicrafter speaker to match, whole new just pre-war and stored for duration; offers over £65.—Sillcora, 33, Virginia Rd., New Brighton, Cheshire. [5851

**E**X-R.F. transmitter-receivers, model TR9, complete with 9 valves, new condition, ready for operation, or contains many useful items for your rig, relays, short-wave condensers, silver-plated inductances, thermo-coupled meter, milliammeter, etc.; £6 carriage paid; trade enquiries invited.—Stamford Radio Co., 199, Stamford St., Ashton-under-Lyne.

**TEST EQUIPMENT**

**M**UIRHEAD all-wave osc., £10; Triplett uni. meter, £2.—Box 1768. [5839

**C**ROSSOR doub.-beam scope with home-built wobblulator; £45.—James, 72, Kimberley Rd., Croydon. [5899

**C**ROSSOR 339A D.B. oscilloscope, as new, inspection North London.—£40 or best offer to Box 1886. [5891

**A**C/DC M/c voltmeter, 260v, 4 1/2in dial, A 80/-; Milnes unit, 150v, 60/-.—Dobson, Gasstown, Dumfries. [5867

**M**URPHY P.1 oscilloscope, T.B. 4 1/2in, 13,000c, freq. mod., £35.—Cook 93, Wellington St., Leicester. [5854

**C**ROSSOR 339 oscillograph, Advance B3-C signal generator, Taylor 110A R/C bridge and other test gear for disposal; enquiries invited; s.a.e.—Hales & Co., Ltd., 162, Lowestoft Rd., Gorleston-on-Sea. [5909



**SURPLUS** to requirements, valve voltmeter, £27/10; resistance and capacity bridge, £13/10; both brand new.—Box 1705. [5829]  
**TAYLOR/METTER** 85A (4,000 ohms per volt), nearly new; Hunts resistance capacity bridge; Universal Avminor.—Offers to McKay, 23, George St., Largs, Ayrshire. [5811]  
**OSCILLOSCOPE**.—Constructor offers drawings and full instructions to build your own oscilloscope; all details of circuit, components values and lay-out, 3/6.—20, Malzeard Rd., Luton. [5569]  
**TAYLOR** 72-range meter, model 81A, 4,000 Ω per volt, with capacity and inductance adaptor, £17; also 12-range ac-dc meter, needs slight repairs, bargain, £3.—Write first to Scragg, 15, Sparrow Terr., Porthill, Stoke-on-Trent. [5958]

**AVOMETERS**.—Model No. 7, £19/10; Universal Avminors, £8/10; dc Avminors, £4/4; B.P.L. signal generators, £21; e.v.o.; immediate delivery; bridges, valve testers, quick delivery; please state requirements.—Young, Radio Service, Southwick, Sussex.

**METERS**, moving coil, 0.5 radio frequency thermo-coupled, 30 millamp scale, 5ma shunted, 15/-; TX coils 16 turns silver plated, 3/4in diameter, air spaced, tap counting dial, 6/6; 3-gang tuning condensers, 50 mmds per section, extension shaft, 7/6; cash with order, add 1/-.—Stamford Radio, 199, Stamford St., Ashton-u-Lyne. [5800]

**TEST** gear, new and unused, model 7 Avometer, £19/10; model 40 Avo, £17/10; Universal Avminor, £8/10; Avo test bridge, £11; Hunts 1946 C & R bridge, £18/18, add 2/6 post; model 45A/P Taylor valve tester, polished oak cabinet with handle and locks, a super job; model 85A Taylormeter; offers for either or both.—Smith, Radio House, Egremont, Cumberland. [5866]

**MOVING** coil meters, British manufacture, 1st grade, brand new, not surplus, 3in square flush mounting modern bakelite cases, 2 1/2in dial, knife-edge pointer, sprung sapphire bearings, 100 microamp 59/1, 1ma 46/1, 50ma 38/1, 100ma 37/1; thermocouple, 1 amp, 61/-; other sizes on request; send s.a.e.; per return of post; money back if not satisfied.—I.H. French, Ingol, Preston. [5955]

**WAVEMETERS**, ex-Govt. class D No. 1, 8,000 kc/s, check frequencies at intervals of 1 mc up to 25 mcs, oscillator crystal check, battery operated, supplied with spare vibrators, spare valve, and instruction book, brand new; £6/15, carriage paid; send for fully descriptive leaflet.—U.E.I. Corp'n., 32, St. Gabriels Rd., London, N.W.2. [5910]

**ALL-WAVE** signal generator, non-drift coil turret (pat. pending), 400 cps. anode modulation, cathode stabilised oscillator, scale calibrated 20 mc/s-100kc/s, 10-3,000m, ruggedly constructed for use in vertical or horizontal position, self-contained handle, integral storage for mains and output leads, 10/6gns; orders in rotation.—R.R. Development Laboratories, Ltd., 26, Hawes Rd., Bradford. [5929]

**BRITISH** Physical Laboratories 14-range Universal test set. The following ranges can be selected by means of a rotary switch: dc volts, 0/75mV, 0/10, 0/50, 0/100, 0/500, 0/1,000. ac milliamps 0/1, 0/10, 0/100, 0/1,000. dc volts 0/10, 0/50, 0/100, 0/500, 0/1,000; resistance 0/1,000 and 0/100,000 ohms. Accuracy 2% over all ranges. Dimensions: 5 1/2in high x 4 1/2in wide x 2 1/2in deep. Retail price £8/17/6. If unable to obtain this high-grade instrument from your dealer, apply to U.K. trade distributors: **RADIO AGENCIES, Ltd.**, 157, Wardour St., W.1. Tel. Gerrard 4456. [5120]

**WE** are now able to undertake the adjustment of resistors and capacitors over a wide range to within 0.1%, customers' own apparatus, including audio oscillators and wave meters, capacitor calibrated to any required degree of accuracy, we can supply special precision radio end mechanical components from the small gear or coil to the complete apparatus for the solution of unusual problems; facilities also available for instrument finishing, including engraving panels and dials, black crackle enamelling, silver, nickel or chrome plating instrument parts.—Lydiat Ash Labs, near Bromsgrove, Worcs.

**DYNAMOS, MOTORS, ETC.**  
**230V** ac generating sets, 250 watts 50/60 cycles, petrol driven, direct coupled, air-cooled, push-button starting, output fitted and suppressed, portable, self-contained and in first-class condition, ideal mobile P.A. or bungalows; £29/10.—Harris, Strouds Bradford, Berks. [5900]

**PETROL**, charging sets, consisting of 1hp 20amp B.B. engine, direct coupled to 13-32V generator, ammeter, cutout, etc., similar to Iron Horse; £30, plus carriage.—Mathew Bros., Matbro Works, Sandy Lane North, Wallington Tel. Wallington 4050. [4785]

# ELECTRADIX

## Headphones—Telephones, etc.

**HEADPHONES**. Single low resistance phone for circuit testing or house telephone, 60 ohms, bakelite case and cap, best British make, with headband and cord, 8/6.  
 High resistance double headphones, as new, with headband and cord, type S.G.B. light weight, sensitive to crystal, 22/6, delivery from stock.



**TELEPHONES** for House and Office. **CONSTRUCTORS PARTS** FOR YOUR OWN SET UP!

- WALL TELEPHONE SETS.**  
 Bracket Mike, vertical or horizontal ..... 10/-  
 Transformer and Condenser for same ..... 5/-  
 Magneto Bell fitted ..... 5/-  
 Switch hook and contacts ..... 2/6  
 Walnut Cabinet 8" x 6" x 3" fitted terminals and connections ..... 5/6  
 Two L.R. watch pattern earphones ..... 10/-  
 Hand Magneto Ringer ..... 12/6

### THE SET As Above 30/-

**HAND COMBINATION** Telephone, Phone and Mike; ebonite body with switch for speech on bell circuit, 6ft. 4-way cord, as new, 15/- (as illustrated).

**SWITCHES**. Dewar panel switches 8-pole, new r.f. switch fitting, 5/- each. 8-way ex-R.A.F. switch box, 3/6. 6-way, 3/- G.P.O. Lab. switches D.P. reversing, for model control motors, etc., 7/6. R.I. 7-stud multi-contact on ebonite panel, teak box base 4 1/4in x 4 1/4in, 7/6. Linked 5 amp. tumbler, 2/6. Yaxley type 3-pole 3-way, 3/6.

**RELAYS**. Send us your enquiries, we have large stocks all in new condition for immediate delivery.

**METER MOVEMENTS**. Moving-coil large movement, 7 1/2 ma. full scale, 1st grade type, with pointer, few only at 21/- each.

**Hand MAGNETO GENERATORS**. Output approx. 70 v., 25 ma. A.C. permanent steel magnet, wound armature, driven by gearing in handle, suitable for A.C. experiments, bell circuits, shocking coils, etc., 10/- each, post g. 1/-. Spare handle only, 1/6.

**DYNAMOS**. D.C. car type circular body for charging 6 volt 10 amps, £4, 12 volt 10 amps, £4 10/-, 24 volts 40 amps, £10, 30 volts 5 amps, £7 10/-, 80 volts 12 amps, £10.

**AUTOPULSE PUMPS**, 12 volt Petrol Pumps, in new condition, 35/-.

**FANS**. D.C. Table Fans 110 and 220 volt, 10/12in, blade and guard, 45/-. Oscillator type, 12in. blade and guard, 55/-. A.C. 10in. Table Fans, 65/-. Fan Motors only, 110 and 220 volt bulkhead size, 35/-.

**BELLS**. Large Tangent iron clad bells, 6in. gong 230/250 volts, A.C., new condition, 42/-. Circular A.C. Bells, 5/8 volts, 3 1/2in. diam., bakelite base 2 1/2in, diam. metal gong, 6/6. House bells, bakelite base, with 2 1/2in. gong, 6/9. Bell Transformers 230/3-5-8 volts, 7/6.

**BUZZERS**. Test buzzers, double contact blades for distant signals or converting for vibrators, robust construction, 8/6. Morse practice buzzers, tunable type in meta. case, 7/6, or bakelite case, 3/6. Tiny Townsend high note wavermeter buzzers, platinum contacts, 10/-.

**G.P.O.** Connection strips of solder tags, telephone type moulded mounting 60-way, 3/6 each.

**MAGNETS**. AC/DC mains magnets, 2-pole 220 volts, 7/6 each. The wonder midget Magnet, alni perm. steel disc, weight only 1/2 oz., 1/2in. dia. 3in. thick with 3/16in. centre hole, 3/6 each. Large selection of horseshoe Magnets in stock. Send for leaflet "W."

**ELECTRADIX RADIOS**  
 214, QUEENSTOWN ROAD LONDON, S.W.8

Telephone: MACaulay 2159

**ROTARY** converters, ac and dc motors, dynamos, generating sets and meters; full lists available; stamp please.—Harris, Strouds, Bradford, Berks. [5704]  
**BATTERY** chargers for home and export, 4 models, 2-6-12v, 1, 2 or 4amp dc, any mains voltage; generous trade terms. Write for catalogue. Tel. Hoddeston: 2659.—The Banner Electric Co., Ltd., Hoddeston, Herts.

**MORSE** EQUIPMENT  
**HIGH-SPEED** Morse key German Naval pattern, adjustable spring tension and contacts, built-in choke and suppressor; £5/5 Box 2439. [5976]

**NEW LOUDSPEAKERS**  
 Mains energised 8in 2,500 ohm field, pen tone output transformer, brand new, 29/6; Bakers, Magnavox, Vitavox in stock.—Whitton Electrical, 46, Hounslow Rd., W.1. ton. Middx. Hou. 3622. [5821]

**LATEST** model broadcast pm loudspeakers, standard model, 12in, 15watt, £7/10; Hi-Fi model, 12in, 15watt, £8/15; 15in and 18in models to follow shortly; Ticonal magnets, detachable diaphragms, die-cast chassis; early deliveries; spec. upon request.—Broadcast and Equipment Co., Ltd., Broadcast House, Tombland, Norwich, Norfolk, [4027]

**LOUDSPEAKERS, SECOND-HAND**  
**NATIONAL H.R.O.** complete with speaker, 230 volt pack and 9 coils; £60.—Crockall, Market Place, Poulton-le-Fylde. [5907]

**FOR** sale, 1 Goodmans 15in P.M. T10/1501/3.5, £15/10; 3 Goodmans 12in T2/1205/15, £5/15 each; all new and unused.—French, Cottam Hall Lane, Ingol, Preston. [5848]

**GRAMOPHONE AND SOUND EQUIPMENT**  
**COIL** pick-up and transformer, new; £6.—Hubble, 42, Station Rd., N.21. [5819]

**L**EXINGTON moving coil pick-up with sapphire needle, less transformer, £6; Marconi moving iron pick-up, £2/10.—Box 1883. [5879]

**HIGH** Quality record reproducer with triode output, specially built by H.M.V. for connoisseur, speaker field has separate power pack and radio input jack is provided; £45.—BM/RADIX, W.C.1. [5850]

**COILS** for "W.W." tone control and filter circuits (Brierley & Hartley spec.), high fidelity, mic. line and output transformers; s.a.e. full list.—R. Clark, 30, Langland Cres., Stanmore, Middx. Wor. 532. [5685]

**VALRADIO** moving coil pick-up, the most advanced pick-up on the market to-day; yours for £8/0/6, including purchase tax, complete with built-in transformer and base compensating unit; response practically flat from 25 cycles to 12 kc; come and hear it; demonstrations every Monday at 3 o'clock; send for descriptive leaflet.—Valradio, 57, Fortress Rd., N.W.5. Gulber 5165. [5547]

**VALVES**  
**6AK5**, 954, 959, 25/-; 955, 958, 20/-; 832, 55/-; two each, all new.—Box 861. [5870]  
**OFFERS** wanted for quantity of American Acorn valves, types 954, 955, 956, all unused.—Box 1107. [5751]

**I**85, 174, 1R5, 334 miniature valves, 17/6 each. All types valves in stock; order c.o.d. Send for component lists, s.a.e.—M.O.S., 24, New Rd., London, E.1. [5966]

**EXPERIMENTER**, disposing of equipment offers Acorns, types 954, 955, 9004; battery midget types 184, 1T4; main midget types 9001, 9002; all new, 10/- each; s.a.e. complete list other bargains.—Box 1889. [5894]  
**COMPONENTS—SECOND-HAND, SURPLUS VALUE!** Matt has it.

**SPECIAL** offers all new goods.  
**SPEAKERS**: Celestion and Goodman, 5in L/T, 15/6; 6in L/T, 17/6; all P.M.  
**ROTHERMEL** crystal pick-ups, de luxe, £2/16/3, inc. P/T.  
**VOLUME** controls: Centralab, all values, 2/6 L/S, 3/6 W/S.

**MAINS** droppers: .2amp 4/-, .3amp 4/6.  
**CONDENSERS**, canned, All 500v working, 8md 2/10, 16md 3/4, 8+8 4/9. .01-.05 .1mf 6/- per dozen.  
**INTERNATIONAL** octal valve holders: 3/- per dozen, 30/- gross lots; 4, 5 and 7-pin 6/- per dozen.  
**LINE** cord: 2-way 1/- per yard, 3-way 2/- per yard; 3amp.  
**TELEVISION** lead-in cable: 1/- per yd.  
**LARGEST** stock of B.V.A. and U.S. valves in England at list prices; we supply anything in radio.

**MATT RADIO SERVICE** (Kingston 4881), 152, Richmond Rd., Kingston-on-Thames, Surrey. [6002]  
**SCOTLAND'S** largest stockists.—Anything S radio we have it.  
**EDDYSTONE**—agents—Raymart.  
**SEND** for parts and kits list.  
**BUCCLEUCH** RADIO MANUFACTURERS, Melville Terr., Edinburgh. Tel. Edinburgh 42803. Grams, Therm, Edin. [5139]



**G.P.O.** Connection strips of solder tags, telephone type moulded mounting 60-way, 3/6 each.

**MAGNETS**. AC/DC mains magnets, 2-pole 220 volts, 7/6 each. The wonder midget Magnet, alni perm. steel disc, weight only 1/2 oz., 1/2in. dia. 3in. thick with 3/16in. centre hole, 3/6 each. Large selection of horseshoe Magnets in stock. Send for leaflet "W."

**ELECTRADIX RADIOS**  
 214, QUEENSTOWN ROAD LONDON, S.W.8

Telephone: MACaulay 2159

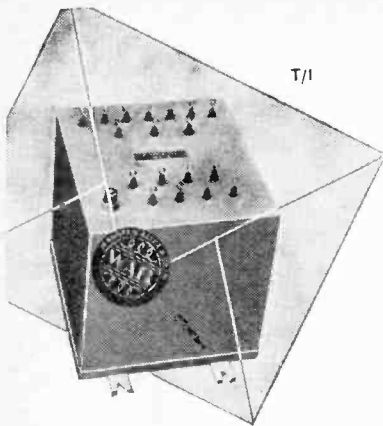

HERMETICALLY  
*Sealed*  
TRANSFORMERS

Designed during the war to meet Service requirements for a Transformer which would operate efficiently under extreme Tropical conditions. Sealed against humidity, termites and other pests. Now in production for general industrial use. Write for full particulars and specifications.

**W. ANDREW BRYCE & CO. LTD.**  
Shenley Road, Boreham Wood, Herts  
Telephone: ELStree 1875 & 1117.

**YOU  
can become  
a first-class  
RADIO  
ENGINEER**

We are specialists in Home-Study Tuition in Radio, Television and Mathematics. Post coupon now for free booklet and learn how you can qualify for well-paid employment or profitable spare-time work.

**T. & C. RADIO COLLEGE**  
North Road, Parkstone, Dorset

*(Post in unsealed envelope, 1d. stamp)*

Please send me free details of your Home-Study Mathematics and Radio courses.

NAME .....

ADDRESS .....

W.W.52.

**CHARLES BRITAIN (RADIO), Ltd.**

**LINEs** of interest and special offers!  
8MPD 500v wkg, B.I. blocks, 3/- each; metal-cased ditto, 3/- each; 25mfd 25v wkg, 1/9 ea; 50mfd 12v wkg, 1/9 ea; 75mfd 12v wkg, 1/6 ea; mains transformers, Woden 100ma 6v, 27/6 ea; Porthminster 80mil 4v or 6v fully shrouded, 27/6 ea; mains droppers, 3-amp, 2 sliders and fixing feet, 4/9 ea; 2amp ditto, 4/6 ea; wavechange switches, 2-pole 2-way, 2/9 ea; 4-pole 2-way, 2/9 ea; 4-pole 3-way, 3/- ea; two-gang condensers with feet, less trimmers, 12/- ea; ditto without feet, 11/- ea; good stocks available. Amphenol valveholders, Int Oct, Mazda Oct, Brit 5-pin, 7/6 doz; coils, T.R.F. medium and long-wave pair; metal-cased 0.1 tubular, first-class quality, 350v wkg, 5/6 doz; 0.5 350v wkg, 6/- doz; 0.01 1,000v wkg, 4/6 doz (note: please order in dozens); midget chassis, 9 1/2 x 4 1/2 in, drilled for 5 valves, etc., 2/6 ea; two-colour M. & L. dials, 1/3 ea.  
**LARGE** stocks of speakers, pick-ups, amplifiers, etc., many bargains for callers; send for list "W"; trade supplied; terms, c.w.o. or c.o.d. £1.—Charles Britain (Radio), Ltd., Radio House, 2, Wilson St., London, E.C.2. Tel. Bix 2966. 16003

**SOUTHERN RADIO'S** wireless bargains.  
**LATEST** radio publications:  
"Radio Valve Manual," equivalent and alternative American and British types with all data 3/6; "Radio Circuits," fully illustrated, receivers, power packs, etc., 2/-; "Amplifiers," fully descriptive circuits, 2/-; "Radio Coil and Transformer Manual," 2/-; "Short Wave Handbook," 2/-; "Manual of Direct Disc Recording," 2/-; "Test Gear Construction Manual," 1/6; "Radio Pocket Book," formulas, tables, colour code, etc., 1/-; "Ten Hows for Radio Constructors," 1/-; "Radio Reference Handbook," cloth bound, comprehensive and up-to-date, covering all branches of radio, 12/6; "American Service Manuals," Sparton-Emerson, Crosley-Belmont (Parts 1 and 2), Stewart-Warner-Fada, Emerson, 12/6 per volume; "Radio Resistor Chart," colour codes at a flick, 1/- each; "Bulgin Radio Service Manual," 2/6; "Radio Constructors Manual," 3/-; postage extra.  
**YAXLEY** type 2-way rotary switches, 5/-; tubular condensers, 0.1+0.1+0.1 in, 2/6; Resistances, brand new wire ended, 1/4, 1/2 and 1 watt, assorted values, 30/- per 100; 1/4 watt only, assorted values, 20/- per 100; 1/2 watt, 22/6 per 100.

**SOUTHERN RADIO SUPPLY Co.**, 46, Lisle St., London, W.C. Gerrard 6653. [5903  
**F**OR sale, H.R.O., M.F. and L.F. coils.—Box 1106. [5750

**ALIGNED INSTRUMENTS SERVICES, 1**, Colworth Rd., Leytonstone E.11.  
**TUNING** Heart kits.—Each kit includes a coil pack and i.f. transformers which have been pre-aligned and gain tested, matched gang condenser, and the components specified in the recommended circuit which is supplied. I.f. transformers are iron cored and permeability tuned; for coil pack details see below; superhet types: Kit No. 5, 16-50, 200-550, 750-2,000 metres; Kit No. 6, 12-30, 30-75, 75-200 metres; Kit No. 7, 16-50, 200-550 metres; Kit No. 8, 200-550, 750-2,000 metres. T.r.f. types: Kit No. 9, 16-50, 200-550, 750-2,000 metres; Kit No. 10, 12-30, 30-75, 75-200 metres; Kit No. 11, 16-50, 200-550 metres; Kit No. 12, 200-550, 750-2,000 metres. Prices: Kits 5 and 6, 75/-; Kits 7 and 8, 65/-; Kits 9 and 10, 60/-; Kits 11 and 12, 50/-; Matched valves supplied for Kits 5, 6, 7, 8, at 38/3 extra; Kits 9, 10, 11, 12, at 25/8 extra; circuit diagrams supplied separately, price 2/6.

**UNIVERSAL ELECTRONIC PRODUCTS (GBUQ)**, 36, Marylebone High St., London, W.1. Tel. Wel. 4058.  
**WE** stock a comprehensive range of the type of components essential to the needs of the amateur transmitter and experimenter, including meters, transformers, parolin, polystyrene aerial equipment, Denco and Raymatt products, etc.; send s.a.c. for lists. Our works, under the personal supervision of GBUQ, are equipped to undertake the construction of all types of radio and electronic equipment, from an extension spindle or small chassis to a complete 500watt transmitter; we are practical people and amateur enthusiasts are always welcome—call in next time you are in town.

**F**OR sale, Baird televisor T.20, in perfect condition; best offer over £50.—Howard, Chemist, Beeding, Steyning, Tel. Steyning 3218.  
**C**ONDENSERS, oil filled, 4 mfd 750v, working, 6/-; Vitreous resistors, 5,000Ω 30w, 3/-; moving coil meters, 0.5 ma, 2 1/2 in sq., flush mounting, 19/6; all new, postage extra.—Parker, The Firs, Calder Grove, Wakefield.

FOR  
**VACUUM  
IMPREGNATION**  
OF  
**RADIO &  
ELECTRICAL  
COMPONENTS**  
CONSULT  
**GRIFFITHS BROS.  
& CO., LONDON, LTD.**  
**VARNISH MANUFACTURERS  
&  
SPECIALISTS IN  
IMPREGNATION**  
**MACKS RD., BERMONDSEY,  
LONDON, S.E.16. BER. 1151**

**PITMAN**  
*Radio Books*  
**THERMIONIC VALVE  
CIRCUITS**

By Emrys Williams. Can be recommended as a complete and up-to-date guide to theory and application. Second Edition, containing an original theorem on valve oscillators, and other additions. 12/6 net. (Postage 4d.)

**RADIO RECEIVER  
CIRCUITS HANDBOOK**

By E. M. Squire. A useful guide to circuits for members of the radio industry and radio amateurs. It covers all types of receivers. Profusely illustrated. 6/- net. (Postage 3d.)

**PROBLEMS IN  
RADIO ENGINEERING**

By E. T. A. Rapson. A classified collection of examination questions in Radio Communication set by important examining bodies, together with useful notes and formulae. 5th Edition. 5/- net. (Postage 3d.)

**MODERN BOOK CO. (Dept. 2W)**  
19-23 Praed Street, London, W.2.

# GALPINS

GOVERNMENT SURPLUS ELECTRICAL STORES  
408 High St., Lewisham, London, S.E.13

Telephone: Lee Green 0309. Near Lewisham Hospital

TERMS: CASH WITH ORDER, NO C.O.D.

EX-G.P.O. MAGNETO GENERATORS, hand-driven approx. output 75 volts 20 m/amps A.C. useful to the experimenter, small pattern 7/6 each.

ROTARY CONVERTERS, condition as new. 24 volts D.C. input at 2½ amps 75 volts A.C. 1 phase output 55/- each post 2/6.

USEFUL PANELS comprising of Smoothing Chokes, Mod. Transformers Condensers marked in decibels and various other components useful to the Amateur all components as new 20/- each, carriage 2/6.

HAND COMBINATION TELEPHONES, late Pattern, receiver and Transmitter, ebonite body. 10/6 each post 9d., condition as new. Pedestal Type Telephones 15/- each, Breast Microphones, small ebonite pattern 7/6 each, single earphones with headband, low resistance, condition as new, 6/- each

TRANSFORMERS BY WELL-KNOWN MAKERS, input 200/250 volts 50 cy. 1 phase output 1,500 volts at 3 Kilowatts twice. £12 10s. each. Voltage Regulation Transformer oil type 200/250 volts 50 cy. 1 phase, 7 kW. £15 each, new condition.

RECTIFIERS (SELENIUM) 24 volts 6 amps output 55/- each. 150 volts 300 m/amps output 25/- each. New and unused.

BALLAST LAMPS (GOOD MAKERS), new 125 volt 30 watts E.S. fitting. 6/- per dozen.

METERS ALL BY WELL-KNOWN MAKERS, edge type 1st grade moving coil 2½in. 0 to 3 amps, 35/-; 0 to 2 amps, 35/- . Both the above read 2 ma without shunt. Ditto, 0 to 1 volt 1,000 Ohm. per volt 1 m/a 45/- . Another ¾ Decibel Meter reading zero—10-3 F.S.D. 50 microamps 85/- each. Another 2½in. round face meter 0 to 25 and 100 volts A.C. fitted rectifier 55/- each. All fully guaranteed and condition as new.

LARGE POWER UNITS BY WELL-KNOWN MAKERS, input 100 to 260 volts 1 ph., 50 cycles output 24 volts 11 amps and 130 volts 600 m/amps., smoothed all fitted in metal cabinet size 5½in. X 10½in. X 12½in. fitted cutout, fuses, relay and switches, new condition, £12 10s. each carriage forward.

VOLTAGE CHANGER TRANSFORMERS. Auto-wound, fully guaranteed, immediate delivery. 350 watts. 55/-; 500 watts, 70/-; 1,000 watts, £5 15s. , 2,000 watts, £8 15s. All tapped 0, 110, 200, 220 and 240 volts.

MAINS TRANSFORMERS, all by well-known makers and fully guaranteed, input 200/250 volts, 50 cy. 1 phase, output 2,000/0,2000 volts at 250 m/amps with 2 L.T. tappings 75/- . Ditto, 475/0,475 volts at m/amps, with 3 L.T. tappings, 4v. and 6v. price 42/6. Ditto, 89, 100, 120, 140, 200, 220, 240 volts at 3,000 watts. £12 10s. Ditto, 6, 16 volts at 14/900 amps output, £15. Transformer cores, suitable for winding 2,000 watts, 27/6; 100 watts, 7/6 each.

EX-R.A.F. 10-VALVE CHASSIS (sold for components only). Consisting of: 2, 160 ohm Mult. Contact Relays, 9 British type Octal Base Valve Holders, 30 Tubular Condensers, ranging from 10 P.F. to 1 M.F. 25/30 Resistances ¼, ½, 1 and 2 watts, all mounted on chassis, size 12in. X 8in. X 2in. Components all in good condition. "A real bargain" at 12/6 each, postage 1/6.

EX-GOVT. ROTARY CONVERTERS, input 12 to 18 volts D.C. at 3½ amps. output 450 volts 60 m/amps fitted with automatic switching and smoothing 32/6 each. 2/6 carriage.

ELECTRIC LIGHT CHECK METERS, guaranteed electrically, 200/250 volts 50 cy., 1 phase, input 5 amp type, 12/6, 10 amp type, 15/- each. Carriage 1/- . D.C. MOTORS, approx. ½ h.p. series wound, all guaranteed electrically for 110 or 250 volts mains Price 15/- each. Carriage 1/- .

HIGH-GRADE SWITCHBOARD TYPE AMP. METERS, 5in. dial for A.C. or D.C. calibrated 50 cycles, 0 to 30 amps., 32/6 each. Ammeters moving coil, 3in. dial 0 to 10 amps., 20/- each.

LARGE TYPE RECTIFIERS, 12 volts 4 amps., 45/-; 12 volts 6/8 amps, 55/-; 6 volts 1 amp., 12/6; 50 volts at 2 amps., 42/6. All fully guaranteed.

MAINS TRANSFORMERS, to suit the above 12 volt rectifiers, with tapped output of 6, 12 and 24 volts at 6 to 8 amps., 40/- . Carriage 2/- .

SELENIUM metal rectifiers, guaranteed charger kits, etc.; no surplus goods stocked.

LARGE selenium metal rectifier, 12V 3amp type, with 50 watt transformer and ballast bulb for 2v to 12v charger, weight 7lb, no rheostat or ammeter required, 47/6, post 1/-; ditto with 2amp rectifier, 39/6; ditto with 75-watt transformer, 59/6, post 1/1; heavy duty transformer and rectifier for 12v 5amp, tapped at 6v, 44/5; trickle charger rectifier, 2v ½amp type, with transformer, makes ideal trickle charger for 2v cell, guaranteed one year. 13/6, post 7d.; transformer, metal rectifier, ballast bulb for 1 to 20 cells at 1amp, ideal for small radio store, one year guarantee, 25/5; ditto for 2amp charge, 27/5; rectifiers, selenium type, 12v 1.5amp, tube proof finish, 10/6, post 7d.; 12v 0.75amp, trickle type, 7/6, post 4d.; 12v 2amp, 15/-; 12v 3amp, 21/-, post 9d.; 12v 4 amp, 27/6; 12v 5amp, 32/6.

ELIMINATOR rectifiers, latest type, 120v 20ma, 7/-, post 4d.; also eliminator kit, transformer, rectifier, two 8mfds condensers, for 120v 20ma, 32/6; ditto with 2v trickle charge, 37/6, post 8d.

CHAMPION, 43, Uplands Way, London, N.21. Tel. Lab. 4457. [6136

G6V8 for ham gear, Eddystone, Pullin, etc., with many bargain lines; s.a.e. for lists; G6V8.

—Carlton Music Salon, West Kirby, Cheshire.

SUPREME RADIO, 746b, Romford Rd., Manor Park, London, E.12.—Goods for every-day service, deliveries from stock, no waiting.

0.1 TUBULAR condensers, 500v working, 5d. ea., 4/- doz.; 0.01 ditto, 4/- doz.; ½ watt and ¼ watt resistances, useful sizes, assorted, well-known makes, 3/- doz.; wire wound resistances, 1 and 2 watt, assorted, 3/- doz.; 0.25 tubular condensers, wire ends, 9/- doz.; 25-25, 18/- doz.; 50-12, 18/- doz.; 8mf 500v working, 30/- doz.; line cord, 60-70d, 1t, 15/- doz. yards, 3-way; 0.0003 reaction condensers, 16/- doz.; 0.005 2-gang condensers, trimmers, fixing feet, 11/-; 3-gang, 13/-; 0.2 droppers, 2/6; 0.3 droppers, 4/-; v/cs, best makes, with switch, 2/5; less switch, 3/9; job line 2,000Ω wire wound v/cs, to clear 18/- doz.; Pye replacement transformers, 24/- doz.; fluorescent chokes, 200-250v, 24/-; 30w p.p. transformers, 22/-; m. and l. coils, midget circuit, 6/6; m.w., 6/-; s.m.l., 8/6; dials, 3½x4in, all-wave, 1/6; m.w., 1/6; all-wave glass, 9¼x4¼in, 3/-; ivory 6x6 all-wave, 2/-; switches for same, 2/3; heavy chokes, 100mils, 10/-; 60mils, 6/-; mains transformers, from 4/- each; job line l.f. transformer, 1/- ea.; 0.01 Mansbridge condensers, 2/6 doz.; 1+1mf condenser, 250v working ac, 350 dc, 6/- doz.; valves, job line, 5Y3, 80, 1D5, and many other odd makes, to clear 7/6 ea.; we stock all types of B.V.A. valves; send for list, enclose s.a.e. all enquiries; send 6d extra for postage s.a.e. all countries; no c.o.d.

HENRY'S RADIO & ELEC. COMPO. HENRY'S, 5, Arrow Rd., Edgware Rd., London, W.2. Pa. 294. Hours: 9.30-6 o'clock, Mon-Sat. Thurs. 1 o'clock. T.C.C. and B.I. 8mf 500v wkg, 3/-; 8x8mf 500v wkg, 6/-; 16mf 500v wkg, 4/- Metal rectifiers, input 200-600v, output 300ma, 30/-; 280 volts 60ma, 10/-; 4mf 1,000v wkg, 7/6 ea.; oilfilled 1mf 1,000v wkg, 3/-; oilfilled 2-gang 0.0005 standard condenser with trimmers, 12/6; 4-gang 0.0005 standard condenser, 10/-; Amphenol v/holders, 4, 5 and 7-pin English and Mazda Octal and Int. Octal 4 and 5-pin U.X., 9d. ea., 7/6 doz. [6162

RADIOGRAPHIC, Ltd. (B.R.S. 12040), of Glasgow, are forging ahead in getting supplies of vital interest to all radio enthusiasts; keep in constant touch for the latest news of still greater supplies.

TRANSmitters, transceivers, valves (RX and TX), and all components. RADIOGRAPHIC, Ltd., 66, Osborne St., Glasgow, G.5. [5516

TRANSFORMERS Prim. 230v sec 350-0-350v 150ma, 5v 2a, 6.5v 2a, 6.5v 2a, fully interleaved, 32/-; moving coil meters, 3½in flush mounting, 200 microamps, 55/-; moving coil mike inserts, 7/6-5s, Cooper Rd., Kexbro, Barnsley. [5885

VORTEXION transformers and chokes, etc., supplied to B.B.C., G.P.O., L.P.T.B.; why not you? wound to any specification; imitated but unequalled.—Vortexion, Ltd., 257-261, The Broadway, Wembley, S.W.19. Tel. Liberty 2814-6128.

EX-GOVERNMENT bargains.—Engineers' 12in combination sets, 37/6; two-speed breast drills, takes up to ½in drill, 35/-; engineers' hammers, 2/-; 6in steel squares, 2/6; 4in 2/-; outside spring adjustment type calipers, 1/6; 10in sheet metal cutting snips, 3/6; workshop bench vices, 4½in jaws, 27/6; approx. 12 gross different sizes up to ¾in thick aluminium rivets, 6/-; 24 gross 10/-;—Hughes & Sons, 28, Clarence Place, Newport.



## INTRODUCING The WILSON "White Rose" Quality Series of RADIO CONSTRUCTORS' KITS

Only a very limited quantity will be available to commence with. You are invited to write for prices and full details.

**KIT W.R.Q. No. 1: A.C./D.C.** 5 valves including rectifier, superheterodyne circuit, image-rejector, chassis insulated from mains, Octal B.V.A. valves, 3 wavebands (16-47, 200-540 and 800-2,000 metres).

**KIT W.R.Q. No. 2:** As above, but for A.C. only.

**KIT W.R.Q. No. 3: A.C. only.** 3 short wavebands (10-30, 80-75, 70-200 metres). Superheterodyne, 5 valves. Valve sequence: Short-wave H.F. pentode (EF50), F.C. 6K8. I.F. Amplifier EF39, Double diode-triode EBC33, Output EL33, Rectifier AZ31. Low-loss component throughout. Extra smoothing.

**KIT W.R.Q. No. 4: T.R.F.** 2 H.F. stages, 3 wavebands (16-47, 200-540 and 800-2,000 metres). Bandpass on medium and long waves. 4-gang tuning condenser. Diode detection. A.V.C. 8in. P.M. speaker.

**KIT W.R.Q. No. 5: Battery** (low current consumption), 4 L.V. Octal base valves, 3 wavebands (16-47, 200-540 and 800-2,000 metres). Superheterodyne circuit. 8in. P.M. speaker.

**KIT W.R.Q. No. 6: Battery** (very low current consumption), 3 L.V. Octal base valves, 2 wavebands (200-540 and 800-2,000 metres). T.R.F. circuit designed for good-quality reception of local stations. 8in. P.M. speaker.

These kits are boxed complete and have been made to the design and specification of M. WILSON LTD. by STANDARD RADIO LTD. They are guaranteed by the makers to conform to the highest standards of radio components. Iron-cored coils and I.F. transformers are used throughout the kits, and ceramic-insulated tuning condensers, heavy-gauge aluminium chassis fitted with Octal valveholders and sockets for pick-up, aerial, earth and extension loudspeaker, are supplied. We claim that these are the finest kits obtainable anywhere in quality, value and design. Two full-sized blueprints and a theoretical diagram with advice and instructions are contained in every box.

No government-surplus components, British or American, are used on these kits, but only new goods obtained direct from the manufacturers. B.V.A. valves supplied throughout.

### TO OVERSEAS TRADERS

Wholesale and retail enquiries are invited. All essential components for EXPORT-ORDERS are tropicalized if required. Orders can be executed for B.A.O.R., C.M.F. and S.E.A.C. customers.

**307, HIGH HOLBORN**  
LONDON W.C.1. Phone: HOLborn 4637

**COULPHONE RADIO**, Station Rd., New Longton, Nr. Preston.—The return of Post Mail Order Service. New goods only. C.O.D. or cash with order. Orders over 5/- post free. Note prices.  
**EDDYSTONE** Model 504 communications receiver. Rotational dials now commenced.

**ALL** Yunggram and B.V.A. valves; list prices.  
**LINE** Cord, 3 amp, 60Ω per foot, 2-way 1/6 yd., 3-way 1/9 yd.; mains droppers, Feet, 2 sliders, 2 amp 4/3, .3 amp 4/6.  
**GOODMANS** T2/1205/15 12in P.M. quality speakers, £6/15; Goodmans T10/1501/3-5 15in P.M. super quality speakers to handle, 25 watts, weight 28¼lb, £18/10.

**1946 AIRMASTER** 5v superhet chassis with 8in M.E. speaker, all ready to switch on; 15/30, 50/60, 200/550, 800/2,000 metres, high-class job; £16/10; carr. paid pass. train.  
**WEYMOUTH** 3-waveband coil packs, com. wired and tested, for 465 kcs, 38/6; matches, pairs, Midget iron-cored I.F. trans., 19/6.  
**TUNING** condensers, Midget 2 gang, 0.0005 mfd, with 2 speed reduction drive and rubber mountings, 16/6.

**MAINS** transformers, highest quality, primaries tapped, 200/250 volts, 300/0/300, 60 m.a. 4v 3a, 4v 2a or 6.3v 2a, 5v 2a, 17/6; 350/0/350 100 m.a. 4v 6a, 4v 2.5a or 6.3v 3a, 5v 2a, 24/1, bobbin 15/6; 450/0/450 200 m.a. 4v 8a, 4v 4a, 4v 4a or 6.3v 4a, 6.3v 4a, 5v 3a, 42/6; or 6.3v 6a, 4v 2a, 4v 2a, 5v 3a, 45/1.

**EDDYSTONE** short-wave components.  
**BPL** Test Sets, 17 range, latest type, £8/8/8 nett.

**SEND** 2/6d. stamp for every 12-page catalogue.  
**TRANSFORMERS** for every purpose, high test grade workmanship, complete price, immediate delivery; microphone, inter-valve and P.P. driver trans, O.P. trans, 1 to 60 watts; chokes, all sizes, fluorescent light chokes; mains trans to 2kva auto-trans, 60va to 2kva (200-230v, 115v and 24v at max. current); test gear trans for bridges, oscilloscopes, valve testers, etc.; list 1d.—Radio Services, Field St. Works, Blackpool, Tel. 1250. 75002

**UNIT** construction radio, 3-wave superhet tuner unit, complete 3 valves, dial, etc., £6/10; output units, A.C. or A.C./D.C., 2 valve, 4-watt, with output transformer, £2/10; 4-valve, 8-watt, ditto, £3/15; A.C. power unit, £3/10; A.C./D.C., £2/10; sub-chassis to mount 3 units, 6/-; 3-wave coil packs, 37/6; midget high Q I.F.T.s, 21/- per pair; 2-gang with S.M. drive 15/6; 16E aluminium, 2/6 per sq ft, cut to size; chassis made to order.

**R. T.**, 64, St. Leonard's Rd., S.W.14. [6161]  
**GEE ELECTRIC**, 15, Little Newport St., London, W.C.2. Ger. 6794.—All current British and American valves in stock at B.O.T. prices plus tax sent per return c.o.d., med., long and short all wave superhet kits, complete with valves and speaker, less cabinet, 10/15; Universal Avo Minor test meter, £8/10; Wearite Midget I.F.T.s, 460 k.c., iron cored, 10/6 each; 120 car radio vibrator transformers, 18/6; and many other lines; send s.a.e. for list; orders under £1 plus 1/- postage, over £5 registered. [5745]

**S. G. BROWN** Headphones, type A, adsk. stable rev movement, 57/6; type F, feather weight, 25/-; Rothmans crystal pick-ups, 52/2; Goodman loud-speakers, type T2/1205/15, 12in pm, £6/15; electrolytic condensers 8in dia, 500 volts, 2/7; 50mfd, 50 volts, 4/-; T.C.C. condensers, all types, paper block, paper tubular, and electrolytics, including micropack and plug-in, at list prices; valves, English and U.S., all available types at list prices; all goods brand new and guaranteed; enquiries invited.—E. F. Symons, Church Rd., North Ferrisby, York. [5888]

**RADIO CLEARANCE**, Ltd., 27, Tottenham Ct. Rd., W.1. Museum 9188.—Selenium rectifiers, 24v 2a, bridge, 12/6; 250v 60ma, h.w., 6/6; 3-section metal rect., 108v 50ma per section, 5/6; Mansbridge condensers, 1mf 350v, 9d.; 1mf 1,000v wkg., 1/3; 2mf 450v, 1/6; 4mf 500v, 5/9; 4mf 1,500v wkg., 5watt wire wound pots, heavy duty, 440, 12watt, 4/6; 3-watt type, 100Ω, 200Ω, 300Ω, 500Ω, 1k, 2k, 3k, 5k, 10k, 20k, 2/6 each; carbon pots, less switch, 2.5k, 5k, 50k, 100k, 2/6 each; with switch, 50k, 100k, 250k, 4/- each; switches, 1p, 2 or 3w, 1/9; 1p, 12w, 3/-; 1p, 9w, 3-bank, 5/-; Minibank 2p, 6w, 2/6; electrolytics, 2mf 250v, wire ends, 1/9; 20m, 50v or 25mf 25v, 1/9; 4mf 350v, 2/-; 8m, 500v, 3/3; 250mf type, 2/-; 500mf 20v, 2/6; vitreous resistors, 25w, 120Ω, 200Ω, 2,000Ω, 8,000Ω, 2/- each, with clips; wire ended 3w, 470Ω, 3.9k, 6.8k, 47k, 1/- each; wire wound flat P.O. type 10w, 1k, 2k, 4k, 1/6 each; vitreous 2k, 35Ω, 5k, 2/6; 40w, 14k, tapped at 2k, 3/-; condensers, high voltage mica, 0.002, 1,000v, 1/-; 0.002, 2,000v, 2/-; mica, 0.002, 1,000v, 1/-; 0.004, 5,000v, 2/6; mains dropping resistors, with 2 sliders, 0.2a, 1,000Ω, 3/3; 0.3a, 800Ω, 4/-; sleeving, 1 doz. assorted lengths, 1-6mm, 1/6; h.f. chokes, 1/6.

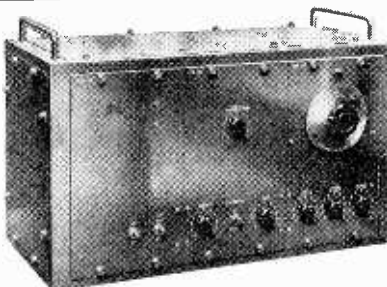

**PUBLIC ADDRESS**  
 by  
**ACOUSTICAL**  
 for the very best in  
**REPRODUCTION**  
**DESIGN**  
**WORKMANSHIP**  
**SERVICE**

We will gladly send you full details and specifications of the full range of ACOUSTICAL P. A. Equipment on request.



MANUFACTURING CO. LTD.  
 HUNTINGDON. TEL. 361.

**LASKY'S RADIO**  
 OUR AIM—SATISFACTION, VALUE AND SERVICE.

**THIS MONTH'S SPECIAL OFFER.**

**PARCEL OF CONDENSERS, RESISTANCES, SYSTO-FLEX, 48 assorted condensers.** All values, including 1.8 mfd., 1.18 mfd., 1.8+8 500 v.w., 48 assorted resistances, ½, 1, 2 watt, 24 yds. Systoflex. Various sizes and colours. 1 lb. reel tinned copper wire. Price 52/6, post free.

**VIBRATORS.** 12 v. and 6 volt, 4 pin, 9/9 each.  
**CONDENSERS.** .5, .25, .1, .01, .02, .05, .03, .025, .001, .002, .005, etc., 7½d. each, 6/- per doz. All 350 volts working. 5 pf.—4,000 pf., 7d. each, 5/6 per doz.

**RESISTANCES.** All values ½, 1, 2 and 1 watt. Assorted parcels. 4/- per doz. £2 per gross.

**HIGH VOLTAGE OIL-FILLED CONDENSERS.** 1,000 volts working, 1 mfd., 2/-; 2 mfd., 2/6; 4 mfd., 6/-; 8 mfd. 750 volts working, 7/6; 1 mfd. 8,000 v.w., 10/-; .02 mfd. 6,000 v.w., 3/6; .02 mfd. 8,000 v.w., 6/6.

**ELECTROLYTIC CONDENSERS.** 500 v.w. aluminium cans (midget), 8 mfd., 3/-; 16 mfd., 4/6; 8+8 mfd., 5/6.

**CARBON VOLUME CONTROLS.** All values. With switch, 5/-. Less switch, 3/6. First grade wirewound Potentiometers. 1,000, 10,000, 5,000, 2,000, 3,000, 20,000, 60,000 and 25,000 52, 3/3.

**YAKLEY TYPE SWITCHES.** 3 pole, 3 way, single bank, 2/6; 4 pole, 2 way, 2 bank, 2/9; 4 pole, 3 way, 2 bank, 3/6. Midget, 2 pole, 6 way, 2/6.  
**OILS.** L. and M. Wave T.R.F., with reaction, 9/6 per pair, with circuit. Weymouth Superhet Coil Pack, L. M. and S. Wave, complete with switch sliders, trimmers, with set of diagrams for building AC/DC Superhet, 38/6. L. M. and S. Wave S/Het coils with circuit. AE and OSC., 10/6 pair. Wearite "P" Coils. PA1, PO1, PH1, PO2, PA2, PH2, F3, PA3, PH3, PO4, etc., etc., 3/- each.

**Loud Speakers, Mains Transformers, O/Trans., Chokes and all radio components.** Everything for the serviceman and amateur radio enthusiast.

Send 1d. for our Current List. ALSO LATEST BULLETIN. All goods sold covered by our Guarantee. Money Returned if Dissatisfied.

Terms: Cash with Order, Pro Forma or C.O.D. (No C.O.D. under £1.)

**LASKY'S RADIO**  
 370, Harrow Road, Paddington, W.9  
 (Opp. Paddington Hospital). Phone: Cunningham 1979

**G. A. RYALL**, 65, Nightingale Lane, London, S.W.12. Mail order only, at present, no C.O.D. under £1 please. Postages extra U.S.A. make 0.1mf 500v tubular metal cased wire end condensers, 5/- doz; 0.5mf 3 2/-, or 6/6 doz. Resistances, carbon type, best make, ¼watt sizes, 47, 100, 220, 270, 500, 1,000, 2,200, 5,000 15,500, 50,000 1.5meg, 2meg, 3/- doz. Best makes 2watt carbon resistors, 6,800, 36,000, 43,000, 140,000, 150,000, 220,000, 470,000, 500,000, 4/- doz. Good assortment 15 sizes of ¼w, ½w, 1w resistances, at 1/6 doz. and 1,800 wire wound 1/6 doz, 2,200 1/- doz. Vitreous 30ohm and 47ohm, 1/6 doz. Vitreous 4,700ohm 20w with clips, 2/- each. Panels with screened 0.1mf and 12 ¼w resistances and condensers, 2/3 each. Set five 30mm trimmers on metal base, 1/- Pairs of dials, 8d. Octal plugs with metal caps 3 1/-. with solder tags 2 1/-; chassis mounting valve holders to suit plugs, 3 1/-. Valve holders, U.S.A. 4, 5, 6-pin and British 7-pin and Inter national Octal, all 6/- doz. Miniature 4-pin plug sockets, metal caps, 4/6 doz complete. Relays, 150ohm 2v 15ma, 2p, M & B, 1p CO high class ceramic insulation, British make, unused, 5/- each. Volume controls less switches, best makes, ¼meg, bakelite cased, ¼meg metal cased, 1meg bakelite cased, short spindles, all 1/6 each; 1meg with 2½in spindle, 2/-; Switches, Yaxley type single bank 1p 9-way, 2/3; 10-way, 2/6. Double row, 2p, 5-way, 2/6; single bank, 2p, 2/-; three bank, 1-way 2p with middle screen, etc., 3/9.

**SERVICEMEN.**—The following products are well designed and of high quality; volume controls, carbon type, all values, with or less switch, wire-wound resistors, 1 to 60watts; dropper resistors, 0.2 and 0.3 amp; line cords and razor resistors; terms and quotations on req.—Dagole, Ltd., 5, Torrains St., London, E.C.1.  
**SALE** to clear, large stock of new small sale condensers, first class quality: 25 500v, 0.1 500v, 0.1 350v, 0.01 1,000v, 4d each; 0.1 500v, 0.1 350v, 0.01 one kind, 3d each; and 1 ex-Army No. 58Mk1 transmitter and receiver complete, including spare kit of 8 valves, can be seen working, £15.—B. King, 24, Cranhurst Rd., Willesden Green, N.W.2.

**SANGAMO** Synchronous Motors, self-starting, exceptionally good torque; rotor speed 200rpm, 200-250v ac, 50c, consumption 2½watts. Size 2½x2, geared 1 rev. min. can be reset to zero by friction drive from front or back; shaft ¾x1/10, to run clockwise; ideal movements for making electric clocks, time switches, etc.; nickel-plated finish; price 22/6 each; 12 to 1 dial trains to fit above spindle, per set 2/6.

**CHAMBERLAIN & Hookham** Synchronous Motors (enclosed type), self-starting, exceptionally good torque, rotor speed 200rpm, 200-250v ac, 50c, consumption 3 watts, size 2½x2, geared 1 rev. min. can be reset to zero by friction drive from front or back; shaft ¾x1/10, to run clockwise; ideal movements for making electric clocks, time switches, etc.; nickel-plated finish; price 25/- each; 12 to 1 dial trains to fit above spindle, per set 2/6.

**CASH** with order post paid on all above goods.  
**TO** callers only a comprehensive stock of scientific instruments, meters, gears, relays, etc. 11. FRANKS, Scientific Stores, 58, New Oxford St., W.C.1. Tel. Mus. 9594. [5805]

**ROTARY** transformers, brand new, ex-Govt. stock, with 6v input, output 200v at 50ma continuous, or 150v at 80ma up to 3 hours, with 12v input, output 480v at 40ma continuous or 400v at 80ma up to 3 hours, size, length 7½in, height 3½in, weight 6¼lb, original price £7/7, each 25/-; midget m. wave t.r.f. coils, high gain, 5/-; m.l. wave, with reaction, circuit, 7/6; m.l. wave, iron cored, adjustable cores, circuit, 10/6; s.m.l. core and osc. coils, circuit, 10/6; Weymouth midget i.f.s. iron core, 465kcs, per pr. 19/6; standard i.f.s. 465kcs, per pr. 15/-; Weymouth all-wave coil pack, 38/6; coloured ivorine dials, s.m.l. wave, 4x3½in, 2/-; 5x5½in, 2/6; slow motion drum drive, 3/-; epicycle drives, 3/3; square plane drive assembly, complete with station named dial, 4½x3½in., m.l. wave pointer glass, escutcheon, etc., 11/6; miniature rotary switches, 4r 3w, 4/-; 2p 6w, 2/6; d.p.d.t., 3/-; chokes, midget 50ma, 5/6; standard 80ma, 8/6; heavy 150ma, 12/6; Simplex chassis, 11x4½x2in, at 6/-; W5V chassis for coil packs, 11½x5½x2½in, at 6/6; 5V chassis for superhets, 10½x6½x3½in, at 6/6; all chassis with 6in speaker cut-out and fully drilled all component holes; nuts-screws, 6 BA, 4 BA, per gross (2 gross in all), 6/-; heavy duty output P.P. trans., 6,600, A to A load, tapped output, 7.5 and 15ohms, each 21/-; 2½d comprehensive lists, well worth having, 2½d stamp; postage all orders.

**O. GREENFIELD**, 44, 34, Bancroft Rd., Cambridge Heath, Rd., London, E.1. Tel. Stepney Green 1334. [6134]

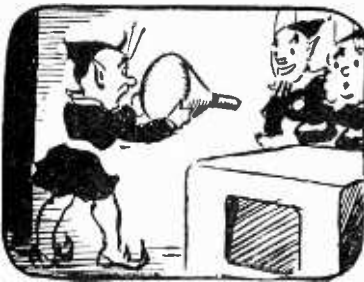

**THE "FLUXITE QUINS" AT WORK**

"So much for this new television,"  
Said Ol with a note of derision.  
Said EE, "Set it right!"  
Wire it up! Use FLUXITE!  
Your views need decided revision!"

See that FLUXITE is always by you—in the house—garage—workshop— wherever speedy soldering is needed. Used for over 30 years in Government works and by leading engineers and manufacturers. Of all Ironmongers—in tins, 10d., 1/6 and 3/-

Ask to see the FLUXITE POCKET BLOW LAMP, price 2/6.

**TO CYCLISTS!** Your wheels will NOT keep round and true unless the spokes are tied with fine wire at the crossing. **AND SOLDERED.** This makes a much stronger wheel. It's simple—with FLUXITE—but IMPORTANT.

The FLUXITE GUN puts FLUXITE where you want it by a simple pressure. Price 1/6, o filled. 2/6.



ALL MECHANICS WILL HAVE

**FLUXITE**  
IT SIMPLIFIES ALL SOLDERING

Write or Book on the ART OF "SOFT" SOLDERING and for Leaflets on CASE-HARDENING STEEL and TEMPERING TOOLS with FLUXITE. Price 1d. each.

**FLUXITE LTD.**  
(Dept. W.W.), Bermondsey Street, S.E.1

**T**RANSMITTING and receiving aerial, sectional copper rod, with permanent flexible contact throughout, 9ft total assembled length, complete with solid rubber mounting base and connecting terminal, 17/6 each; potentiometer assemblies, consisting of 5 assorted potentiometers, values 50K, 20K and 5 meg, together with 2 0.1 tubular condensers, 8/11 the lot; 100K midget volume controls, U.S.A. manufacture, 5 for 10/-; send 2/6 for leaflet on our portable wavemeter.—M.O.S., 24 New Rd., London, E.1. [5853]

**G. W. SMITH & Co. (RADIO), Ltd.**, offers the following:—0.1ma. meters, m/c 3in 35/-; selenium rectifiers, output 180 volts 40ma, 12/6; transformer for same, 22/6; resistors, 20 watt, low tolerance, 500, 1,000, 2,000, 2/- each; See electric clock movements, self starting, geared to 1min. per rev. 32/6; 0.24volt meters, 2in, 10/- each; relays, 1,000, 2,000 ohms, single and multi, 5/- each; 0.2 amp. meters, S.T.C., 3in, 22/6; Tannoy hand microphones, multi cell with switch cases, only slightly soiled, 7/6 each; chassis 25 x 10 1/2 x 4 1/2, 12/6; 10 1/2 x 6 x 3, 2/-, in lots of 12 1/6; condensers, 2mfd, 250v, 1/- each, 9/ dozen; lmd. tuh, 400v 1/6 each; 0.1mfd, 1,000v, 3/6; 0.25mfd, 2,500v, 3/6; 0.25mfd, 3,000v, 4/-; 0.1, 3,000v 4/-; 0.25mfd, 8,000v, 7/6; 0.1mfd, 10,000v, 0.02mfd, 10,000v, 10/- each; 500mfd, 12volt 2/6; 20mfd, 100v, 6/-; Ssec. time control relays, 12/6 each; signal generators, 4 band, 124 mc/s, 118mc/s, 100 mc/s, 98.56mc/s, with valves, less crystals, in very good condition, but not guaranteed, £5 each, carriage 10/-; 7/22 heavy duty twin rubber cable, 60/- per 100 yards; cash with order; postage extra.

**G. W. SMITH & Co. (RADIO), Ltd.**, 2, Cecil Rd., Southgate, London, N.14. [5902]

**M. HELLAS, RHOUS**

**ELECTRONIC manufacturers.**—Join E.M.A.—Particulars from The Secretary, Vernon House, Sicilian Ave., W.C. [5920]

**OFFERS** wanted for "Wireless World" volumes 38 to 43, 1936, 7 and 8, first four bound.—Shatlock, The Shieling, Hamble. We have for disposal a substantial quantity of interohm sheets as used for switch-board panels, arc shields and dividing fillets; the standard grey is also used for bench caps; samples and prices upon request.

**LANGLEY LONDON, Ltd.**, 161, Borough High St., S.E.1. Phone: Hop 2946. [5600]

**3-GANG** ceamic variables, with band spread slow motion "Nolash" drive, 23/6; 1,000 volt working 8, 4 and lmd condensers, fit and forget.—Whitton Electrical, 46, Hounslow Rd., Whitton, Middx. Hou. 3622. [5822]

**TELEPHONE manufacturers and wholesalers.**—Telephone hand-sets for intercommunication; complete telephone units for ships, factories and mines; carbon insets, switch keys, jack plugs and chokes; all new material; export enquiries invited.—Jack Davis, 30, Percy St., London, W.1. Mus. 7960.

**ROTARY transformers**, 12 volts D.C. input, R output 275 volts, 110 m/a and 500 volts 50/80 m/a simultaneously, ideal for P.A. or mobile transmitters; bargain, £3/17/6 each, carriage extra; tough rubber 3-core flexible cable, 7d. per yard; 50 mfd 12-volt tubular electrolytics, 11d. each; 0.5 mfd 450-volts tubular paper.—Austin Mills, Ltd., Lower Carrs, Stockport. [5432]

**WANTED, EXCHANGE, ETC.**

**GOOD** price given for 25-D8-GT valve, octode base.—Box 1624. [5814]

**WTD.**, "W.W.", Feb. & May, '44.—Phone Norman, Bugh Health 338. [5871]

**WTD.**, HRO, RCA88, NC91X. Details, price. Service.—"Finn," Raffees," Walth on Dearne. [5871]

**WANTED.** Service sheets, all makes, from 1936.—Condition and price to Box 1860. [5855]

**E.M.I.**, hypersensitive pick-up units; state price, condition, etc.—Box 1887. [5892]

**MULLARD** valve, P.M.15, wanted.—H. L., 42, North Crescent, Finchley, N.3. [5842]

**COILS** wanted, Colvern Ferrocast G10, 11, 12, 14.—Hambly, 37 Trelawney Rd., Bristol. [5849]

**BAKER** 12in P.M. triple cone, practically new; £3/15, or exchange gram. motor.—Box 1790. [5843]

**WANTED.** communication receiver, in good condition, preferably AR88; £50 offered.—Box 1746. [5833]

**WANTED.** Voigt l.s. units, horns, reflector speakers, any condition.—Lowther Mfg. Co., Bromley, Kent. [5625]

**WANTED.** Voigt corner horn, with or without unit, good price paid.—163, Park Lane, Weymouth, Dorset. [5887]

**SERVICE** sheets and circuit diagrams required for every make of British receiver.—Prices to Box 1858. [5861]

**WANTED.** all types of laboratory and test ing equipment; all letters replied to.—Harris, 29, Bute St., Aberdeen. [6021]

**URGENTLY** required by ex-serviceman, service sheets all makes, 1934 onwards.—Condition and price to Box 1863. [5869]

**PREMIER RADIO Co.**

**MORRIS & CO. (RADIO) LTD.**

All Post Orders to

167 Lower Clapton Rd., London, E.5

'Phone: Amherst 4723

Callers to

169 Fleet Street, London, E.C.4

'Phone: Central 2833

Our New List is now ready. Price 2½d. post paid.

**RADIOGRAM CABINETS.** Dignified appearance and good workmanship. Size 34in. high, 19in. deep, 30in. wide. Send for illustration. Cabinet only, £26. With Electric Motor and Pick-up, £32/16/- With Record Changer, £42/16/-.

**ROTARY TRANSFORMERS.** Size only 7in. by 4in. diameter. With 6 v. input; output 200 v. 50 m/a. With 12 v. input; output 400 v. 80 m/a. Price 20/-.

**ROTARY TRANSFORMERS.** With 12 v. input; output 600 v. 250 m/a. With 6 v. input; output 280 v. 250 m/a. Price £3.

**PLAYING DESKS.**—Consist of an Electrical Gramophone Motor with 12in. table, and speed regulator, a quality magnetic Pick-up mounted on a strong metal frame. Price complete, £6/7/6; without Pick-up, £5/10/-, No auto stops available for either above. Delivery from stock.

**MIDGET RADIO KITS.**—Complete with drilled chassis, valves and loudspeaker, only cabinet required, medium and long wave T.R.F. Size 10in. x 6in. x 6in., 4 valves, inc. rect., tone control, A.C./D.C. operation, 200/250 v. Circuit and constructional details supplied. Price, including tax, £6/17/6. Cabinet, if required, 28/- extra.

**FIRST GRADE OIL FILLED PAPER CONDENSERS,** with miniature stand-off insulators and fixing clips, 2 mfd. 1,000 v.v., 2/6 or 20/- per dozen; 2 mfd. 600 v.v., 1/3 each or 10/- per dozen; 1 mfd. 600 v.v., 1/- each, 8/- per dozen. Super Quality Oil Filled Tubulars. Insulation as good as Mica. 1 mfd. 500 v.v., 5 mfd. 350 v.v. Either type, 9d. each, or 7/6 per dozen.

**CANADIAN R103 CAR RADIOS** at £23/10/-, and No. 58 WALKIE TALKIES at £15/15/- still available.

**PREMIER MAINS TRANSFORMERS.** All primaries are tapped for 200-230-250 v. mains 40-100 cycles. All primaries are screened. All LTR are centre tapped.

List No.	Output.	Price.
SP.175A.	175-0-175 v. 50 m/a. 6.3 v. 2-3 a. 5 v. 2 a.	25/-
SP.175B.	175-0-175 v. 60 m/a. 4 v. 1 a. 4 v. 2-3 a.	25/-
SP.250A.	250-0-250 v. 60 m/a. 6.3 v. 2-3a. 5 v. 2 a.	25/-
SP.250B.	250-0-250 v. 60 m/a. 4 v. 1-2 a. 4 v. 3-5 a.	25/-
SP.300A.	300-0-300 v. 60 m/a. 6.3 v. 2-3 a. 5 v. 2 a.	25/-
SP.300B.	300-0-300 v. 60 m/a. 4 v. 2-3 a. 4 v. 3-5 a. 4 v. 1-2 a.	25/-
SP.350A.	350-0-350 v. 100 m/a. 5 v. 2-3 a. 6.3 v. 2-3 a.	29/-
SP.350B.	350-0-350 v. 100 m/a. 4 v. 2-3 a. 4 v. 2-3 a. 4 v. 3-5 a.	29/-
SP.351.	350-0-350 v. 150 m/a. 4 v. 1-2 a. 4 v. 2-3 a. 4 v. 3-5 a.	36/-
SP.351A.	350-0-350 v. 150 m/a. 4 v. 2-3 a. 4 v. 3-5 a. 4 v. 1-2 a.	39/-
SP.352.	350-0-350 v. 150 m/a. 5 v. 2-3 a. 6.3 v. 2-3 a. 6.3 v. 2-3 a.	36/-
SP.425B.	425-0-425 v. 200 m/a. 4 v. 2-3 a. 4 v. 2-3 a. 4 v. 3-5 a.	47/-
SP.425A.	425-0-425 v. 200 m/a. 6.3 v. 2-3 a. 6.3 v. 3-5 a. 5 v. 2-3 a.	47/-
SP.501.	500-0-500 v. 150 m/a. 4 v. 2-3 a. 4 v. 2-3 a. 4 v. 2-3 a.	47/-
SP.501A.	500-0-500 v. 150 m/a. 5 v. 2-3 a. 6.3 v. 2-3 a. 6.3 v. 3-5 a.	50/-
SP.503.	500-0-500 v. 250 m/a. 5 v. 2-3 a. 6.3 v. 2-3 a. 6.3 v. 3-5 a.	65/-

**ALUMINIUM CHASSIS.**—Substantially made of bright aluminium, with four sides. 10in. x 8in. x 2 1/2in., 7/-; 12in. x 8in. x 2 1/2in., 7/9; 15in. x 8in. x 2 1/2in., 8/6; 20in. x 8in. x 2 1/2in., 10/6; 22in. x 10in. x 2 1/2in., 13/6.

**DOUBLE HEADPHONES** with moving coil chest microphone (as used in tanks). 60 ohms, 15/- the set. Ditto set, but with moving coil headphones, 22/6.

**SUPERSENSITIVE DOUBLE HEADPHONES.** Balanced armature with reed driven aluminium diaphragm. 60 ohms, 8/6.

**ELECTROLYTIC CONDENSERS.** Miniature metal can type, 8 mf. 500 v.v., 8/-; 16 mf. 500 v.v., 4/-; 8 x 8 mf. 500 v.v., 6/6.

**• ALL POWER •**  
**Regulated H.T. Supply Units**



A Range of Standard Models is available, of various output voltages and current ratings. The output voltage is substantially independent of mains voltage or load current within specified limits. Illustrated is the Model 102-A which provides an output voltage from 220-320 volts at up to 250mA, with a Stabilisation Ratio greater than 20,000 and an Internal Resistance less than 0.05 ohm.

**ELECTRONIC EQUIPMENT**

In addition to our steadily increasing range of very high grade test apparatus, we are also prepared to produce specialised equipment to customers' requirements.

**SPECIAL TRANSFORMERS**

We are specialists in the manufacture of very high quality Transformers and Chokes of all types and to any specification.

EXPORT ENQUIRIES INVITED

**ALL POWER TRANSFORMERS LIMITED**

8a, Gladstone Rd., Wimbledon, S.W.19

**METAL CABINETS**

Now delivering ex stock, latest design Steel Cabinets with hinged back and sides, hinged lid. Complete with Aluminium Front Panel size 19" by 10" and finished in Black Ripple. Supplied packed flat for safe transit, can be assembled in a few minutes. Price only 60/- each, plus 2/6 packing and postage. Aluminium Chassis to fit, size 17" by 10" by 2" deep, 6/- (if ordered separately, plus 1/- packing and postage). Aluminium Panel Brackets 7" by 7" 1/- per pair (separately, 9d. extra packing and postage).

Please include P.O. or M.O. with orders for despatch same day, and give name and address in block letters. Smaller sizes will be announced later, also metal handles.

Do try to VISIT us—we're the top of the list for components!

**WIRELESS SUPPLIES UNLIMITED**  
264-266, OLD CHRISTCHURCH ROAD,  
BOURNEMOUTH, HANTS.

**LONDEX for RELAYS**

for A.C. and D.C.

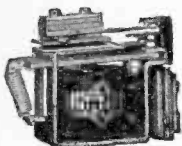

Midget Relay M.L.

2VA Coil consumption from 2 to 600 volts and tested to 2,000 volts. Aerial change-over Relays, Mercury Relays, Measuring Relays, and Time Delay Relays.

Ask for leaflet 205/WW

**LONDEX LTD**

MANUFACTURERS OF RELAYS  
90, ANERLEY ROAD, LONDON S.E.20  
TELEPHONE: 207-4000

**WANTED**, cathode ray tube, 12in, electrostatic, preferably Ediswan 12H.—Buc. 4379. 3, Malvern Drive, Woodford Green.  
**"WIRELESS World,"** Aug., 1931, to Nov., 1934, useful gen. extracts in five bound volumes. What offers?—Box 1862.  
**WANTED**, complete set scanning, focussing coils for 15in Baird CR tube; also W.W., Jan.-Sept., '44; good prices paid.—Box 1885. [5890]  
**TELEVISION** chassis, incomplete or needing repair or set of parts wanted; also 15in magnetic tube.—Preece, 242, Parkside Ave., Barnhurst, Kent. [5886]  
**WE** buy for cash, new, used, radio, electrical equipment all types; especially wanted, radios, radiograms, test equipment, motors, chargers, recording gear, etc.—If you want to sell at the maximum price, call, write or 'phone to University Radio, Ltd., 22, Lisle St., Leicester Square, W.C.2. Ger. 4447.

**REPAIRS AND SERVICE**

**MAINS** transformer rewound and constructed to any specification; prompt delivery.—Brown, 3, Bede Burn Rd., Jarrow. [3460]  
**ACCURATE** radio rewinds, mains transformers, fields, op. transformers, etc.—Southern Trade Services, 297-299, High St., Croydon. [5158]  
**LOUDSPEAKER** repairs, British, American, any make; moderate prices.—Sinclair Speakers, 12, Pembroke St., London, N.1. Terminus 4355. [3308]

**REWINDS** and conversions to mains and output transformers, fields, etc. from 4/6. PP equipment a speciality. N.L. Rewinds, 4 Brecknock Rd., N.7. Tel. Arnold 3390 [5185]

**ELECTRICAL** measuring instruments skillfully repaired and recalibrated, immediate delivery.—Electrical Instrument Repair Service, 329, Kilburn Lane, London, W.9.

**REPAIRS** to moving coil speaker, cones, coils fitted, field rewound or altered; speaker transformers, clock coils rewound, guaranteed satisfaction, prompt service.

**L.S. REPAIR SERVICE**, 49, Trinity Rd., Upper Tooting, London, S.W.17. (4819)

**"SERVICE with a Smile."**—Repairers of all types of British and American receivers; coil rewinds; American valves, spares, line cord.—F.R.I. Ltd., 22, Howland St., W.1. Museum 5675. [1575]

**TESTGEAR REPAIR SERVICE** specialists in repairs, recalibration, etc. of test equipment of every description for the radio industry.—2, Tower Bridge Rd., London, S.E.1. Tel. Ber. 1669. [4506]

**STURDY** rewinds, mains transformers, chokes and fields; we give prompt delivery and guarantee satisfaction; 14 years' experience; prices on request.—Sturdy Electric Co., Ltd., Dipton, Newcastle-on-Tyne. [4316]

**LOUDSPEAKER** repairs.—We are specialists in all types of loudspeaker repairs; keen competitive prices and good service.—Send yours to L. Cottenham, Loudspeaker Repair Factory, 113, Whetley Lane, Bradford, Yorks.

**24-HOUR** service, 6 months' guarantee, any transformer rewound, mains outputs and i.f.s., etc. all types of new trans., etc., supplied to specification; business heading or service card for trade prices.—Majestic Winding Co., 180, Windham Rd., Bournemouth.

**ALL** makes and kinds of electrical and radio instruments repaired by skilled technicians A.I.D. approved; over 60,000 instruments repaired for R.A.F.; all work quoted by return without charge.—C. Gertler, Dept. D, 29-31 Cowcross St., E.C.1. Cle. 6783. [4829]

**REWINDS** mains transformers, speaker field coil chokes, high-grade workmanship, 7-day delivery; new transformers constructed to customers' specification, singly or in quantities.—Metropolitan Radio Service Co., 1021, Finchley Rd., N.W.11, Speedwell 3000. [3719]

**LOUDSPEAKER** repairs, any make, reasonable prices, prompt delivery, to the trade and quality fans; 25 years' combined experience with Rolin, Magnavox, Goodmans, Celestion.—Sound Service Radio, 80, Richmond Rd., Kingston-on-Thames, Kin. 8008. [4977]

**LOUDSPEAKER** repairs.—A.W.F. give prompt service on most types of loudspeakers and horn units, at reasonable charges, to the trade.—Don't write, send complete speakers and horn units only to A.W.F. Radio Products, Borough Mills, Bradford, Yorks. Tel. 11926. [5455]

**TRANSFORMER** rewinds, trans. replacement coils, machine laves wound on bakelite former, interleaved, impregnated and clearly marked; rewinds £1, standard windings to 70 watts, coils 15/6; extra secondaries and larger types pro rata; new transformers or chokes to specification singly or in quantity; trade list on application; delivery by return of post most types; state model and iron sizes when ordering coils, pick-up coils, O/P trans., field coils, etc., rewound or replaced, fully guaranteed.—Radio Services, Field St. Works, Blackpool. R.T.R.A. Service members ph. 1250.

**UNIVERSAL NINE**



**Model AD/9 for UNIVERSAL MAINS PUSH PULL OUTPUT 9 watts.** With mic. and gramo. inputs. Complete ready for use. £12 12 0

**New AC/18 Gramo version.** For A.C. Mains. Assembled. £11 7 0

**AC/18. HG.** As above but with HG mic. stage. Assembled. £13 5 0

**Packing and carriage 2/6 extra on all amplifiers.**

**TUNER UNITS, 6 gns.**

Add-on TRF Radio Feeder units now available. Write for leaflets.

**General Lamination Products Ltd.**

**WINDER HOUSE, BROADWAY, BEXLEYHEATH**

**WARD ROTARY CONVERTERS**

For Radio, Neon Signs, Television, Fluorescent Lighting, X-ray, Cinema Equipment and innumerable other applications

We also manufacture:—

Petrol Electric Generating Plants, H.T. Generators, D.C. Motors, Frequency Changers, etc. up to 25 K.V.A.

**CHAS. F. WARD**

37, WHITE POST LANE, HACKNEY WICK, E.9

'Phone: Amherst 1393

**POST-WAR TELEVISION**

The advance in Radio Technique offers unlimited opportunities of high pay and secure posts for those Radio Engineers who have had the foresight to become technically qualified. How you can do this quickly and easily in your spare time is fully explained in our unique handbook.

Full details are given of A.M.I.E.E., A.M.Brit.I.R.E.E., City & Guilds Exams., and particulars of up-to-date courses in Wireless Engineering, Radio Servicing, Short Waves, Television, Mathematics, etc. etc.

**We Guarantee "NO PASS—NO FEE"**

Prepare for to-morrow's opportunities and post-war competition by sending for your copy of this very informative 112-page guide NOW—FREE.

**BRITISH INSTITUTE OF ENGINEERING TECHNOLOGY (Dept. 388)**

17, Stratford Place, London, W. 1

## LONDON CENTRAL RADIO STORES

### Special Offer of Portable Sound Systems

5 VALVE A.C./D.C. AMPLIFIER with Push Pull Output 6-8 watts, Input 200-250 volts. Complete in Recline Carrying Case. Size when closed 13" x 15" x 10 1/2". Weight 25 lbs.  
With PM Loud Speaker Microphone and Floor Microphone Stand. Ideal for small dance halls, club meetings, etc., etc. **£20.15.0**

### ANOTHER PURCHASE

Moving coil mike inserts, 30 ohms. **5/-**

CENTRE ZERO MOVING COIL 0-100 micro. amps. D.C. meters. **£3.0.0**  
Size 4 inch Panel Mounting made by E.T.E.I. Ltd

### SPECIAL OFFER

2 MOVING COIL METERS 1 Ampmeter 0-3.5, 1 full scale current 100 ma on Aluminium Panel. Size of meters 2 inch. Square. **£3.0.0**

### SIGNALLING TORCHES

Ex - Admiralty 3-cell (type U2) Coloured lenses (red, green and amber) easily unscrewed for use as ordinary torch.  
Powerful beam. Strong metal case. Highly plated zinc reflector, spin. lens with 3.5 v. bulb and spare bulb. Less batteries **12/6**



### FOR FULL TECHNICAL DATA See Editorial Article July Issue

Ex.-R.A.F. Type R1155

### COMMUNICATION RECEIVERS

Comparatively new. These receivers are made to the stringent specification of the Air Ministry and are fitted with a large-scale dial calibrated from 7.5 mc/s to 1,500 kc/s. Complete with 10 valves, including magic eye. Fitted in a strong metal cabinet. They require only a **£17.10.0** power pack to be ready for immediate operation. Aerial tested. These have been thoroughly overhauled and are in good clean condition.

### EX-ARMY No. 58 Mk. 1 Self-contained 8-v. Short-wave TRANS-RECEIVER

- 6-valve Superhet Receiver, 3 v. Transmitter.
- A.V.C.
- Frequency range: 6 mc/s to 9 mc/s (50 to 33.3 metres).
- Working range: 5 miles with 12ft. rod aerial.
- Panel Test Meter for check on batteries and various parts of circuit.
- Chassis suspended in case by rubber shock mounts.
- Three aerials in carrier (12ft. rod, 8ft. 8ins. Telescopic, 25ft. wire).

### BARGAIN OFFER (less Vibrator) £7

As above but COMPLETE with set of 8 spare valves, spare Vibrator and Fuse, 2 Accumulators, 2 Differential type noise-cancelling Mikes, 2 prs. Headphones, 6,000 ohms. Connecting Cables, and

### VIBRATOR POWER UNIT £15

You are invited to call and see the stocks of R.A.F. gear we have for sale. It will pay you!

N.B. We do not issue lists and cannot deal with correspondence on the goods we offer.

Closed Thurs. 1 p.m. Open all day Sat.

23, LISLE STREET LONDON GERrard 2969 W.C.2.

REWINDS, mains transformers, layer wound wax impregnated, O/P transformers, chokes, fields, clock coils, pick-ups, fractional hp motors, competitive prices; prompt delivery; guaranteed work.—W. Groves, Manufacturing Electrical Engineer, 154, Ickfield Port Rd., Birmingham, 16. [4547]

**DEGALLIER'S, Ltd.**—Service with a guarantee. If you cannot get your receiver serviced, let American specialists with proper test gear do the job; first-class workmanship only; we specialise in Air-King, Belmont, Challenger, Emerson, Ferguson, Garod, Halli-crafter, Hammerlund, McMurdo, Midwest, Majestic, Pilot, Scott, etc. also any British set; send s.a.e. with all enquiries. **DEGALLIER'S, Ltd.** 9, Westbourne Court, London, W.2 [5276]

### WORK WANTED

**LABELS**—For the Rig plastic, cardboard, or metal engraved to your requirements; various colours.—Details, "Supervox" Service, 29, Market St., Watford, Herts. [5856]

**CIRCUIT diagrams**—Send us your exact requirements and we will produce a circuit diagram for the radio equip. you want to build; the fee for this unique service is only 5/.—Electronic Service Bureau, Box 1256.

### SITUATIONS VACANT

#### THE UNIVERSITY OF LIVERPOOL.

**RESEARCH assistants, workshop technicians and draughtsmen** required in the department of physics. Salary according to qualifications and experience.

**APPLICATIONS**, which should include particulars as to age, qualifications and experience, together with copies of testimonials, should be received not later than September 14th by the undersigned, from whom further particulars may be obtained.—Stanley Dumbell, Registrar. [5915]

**BOROUGH of Fulham**—Electricity Department.

**RADIO Diagnostic**—Applicants must have had experience in fault tracing in all types of radio receivers, alignment of superhets, use of all types of instruments, and a thorough knowledge of radio theory; television circuitry knowledge an advantage; rate of pay, 2/9 per hour, or £6/9/3 for 47-hour week.

**TERMS** of employment will be in accordance with the N.F.E.A. agreements.

**FORMS** of application for the above position may be obtained upon application to Mr. W. C. Parker, Borough Electrical Engineer, 587, Fulham Rd., S.W.6. [5949]

**RADIO service engineer** required, must be first-class trouble shooter, house avail. in Ascot district to suitable applicant.—Box 1884.

**DEVELOPMENT laboratory assistant** required; must have thorough knowledge and experience of L.F., H.F., and acoustics; London area.—Box 2135. [5926]

**MALE service radio mechanic** required; applicants should write stating age, experience, etc., permanency and prospects for right man.—Write Box 2243. [5938]

**REQUIRED** by Essex firm, experienced technician to take charge of patented electronic instruments; state qualifications, age, salary required, Box 2244. [5939]

**EXPERIENCED radio-television engineer** required.—Apply by letter, stating details of experience, etc., to Staff Manager, J. Holdron, Ltd., 110-148, High Rd., S.W.12. [5943]

**LEADING electrical company** has vacancy for a salesman, 25-40 years of age, in London; good knowledge of radio valves and their application essential.—Apply to Box 2135.

**WANTED**, radio engineer, fully qualified; good position for right man.—Write, stating full particulars of experience and wages required, to A. S. White & Sons, Ltd., 130-132, High Rd., N.15, Sta. 7861-2. [5937]

**PRODUCTION engineer** required by well-known London firm of condenser manufacturers; good salary and scope for right man; must have radio (preferably component) manufacturing experience.—Box 1892. [5897]

**DRAUGHTSMAN (junior)** for London (Waterloo district), basic knowledge perspective drawing, radio and electrical experience.—Applicants should write, stating age, experience and salary required, to Box 2031.

**YOUTH** with electrical knowledge required for position as junior inspector by loud-speaker manufacturers; excellent opportunity, good prospects.—Apply Acoustic Products, Ltd., 50-58, Britannia Walk, City Rd., N.1. [5969]

**VACANCIES** exist in the purchasing department of well-known electrical firm in the Warrington area for buyers and chasers.—Reply, stating age, experience and salary required to Warrington G.P.O., Box No. 20.

**WELL-ESTABLISHED radio electrical firm** requires buyer, with knowledge of stock control and general stores record systems, to purchase and maintain radio, electrical and raw material requirements, preferably with knowledge of production.—Box 2137. [5922]

## NEW Edition—NOW READY!

Get this Catalogue NOW!

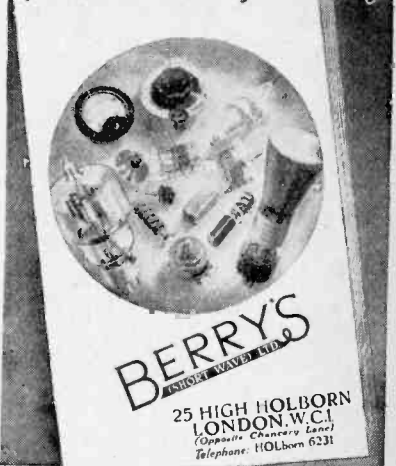

Send 6d. for post free copy.

## EVERYTHING FOR THE HAM AND AMATEUR

SUCH AS

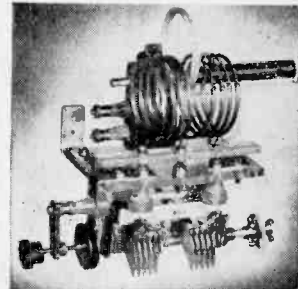

THE "Q-MAX" TANK COIL UNIT

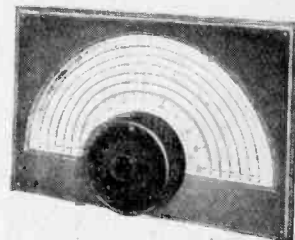

THE "Q-MAX" 50/1 PRECISION SLOW MOTION DIAL FOR COMMUNICATION TYPE RECEIVERS

# BERRY'S

(SHORT WAVE) LTD.

25, HIGH HOLBORN, LONDON, W.C.1

(Opp. Chancery Lane)

Phone: HOLborn 6231

**ILLUSTRATED CATALOGUE**



**NOW AVAILABLE**

Please send 2½d. stamp for post free copy.

Our staff includes: G3AD A. N. Simmonds, G8ZD E. P. Appleby, SPIHH/SP2HH M. Kasia.

**TELE-RADIO (1943) LTD.**

177, Edgware Road, London, W.2.  
Telephone: PADdington 6116.

**TRANSFORMERS & CHOKES**

To Special requirements 14 days  
High Quality Vacuum Impregnated

**AUSTIN MILLS LTD.**  
LOWER CARRS  
STOCKPORT

Telephone: STO. 3791 Established 20 years.

**PUBLICATIONS FOR SERVICEMEN**

- AMERICAN MIDGETS HANDBOOK ... 2/8
- VALVE EQUIVALENTS CHARTS with quick ref. index ... 1/7
- ESSENTIAL VALVE DATA giving base data and diagrams of all valves listed in our valve equivalents charta ... 2/7
- RUNNING A RADIO REPAIR BUSINESS, with notes on starting, and including lists of valves and essential stock ... 7/6

V.E.S., Radio House, Ruislip, Middx.

**A.C.S. RADIO**

**SPECIALISTS IN AMATEUR AND EXPERIMENTAL SHORT-WAVE EQUIPMENT,**

Communications Receivers, Television, High quality Amplifiers, Speakers, Aerials, Receiving and Transmitting Valves and Meters, etc.

List "W" free on request to:-

A.C.S. RADIO, 44, Widmore Rd., BROMLEY, Kent. Phone: RAV 0156.

**NON-MAGNETIC TURNTABLES**

with **STROMBOSCOPIC MARKING**

An essential accessory for serious **PICK-UP DESIGN RESEARCH**

**SOUND SALES LIMITED**

West Street, Farnham, Surrey



Be WISE and PATIENT

**WE** APOLOGISE to those who have been waiting months for replies. Our post-war plans have been frustrated so far. Sorry!

**VOIG PATENTS LTD.**

**LEADING** firm of electronic instrument manufacturers require young engineer for customer liaison and sales of communication equipment. C. and G. Final or equivalent qualification; own car an advantage; state age and salary required.—Box 1987. [5911]

**ESTABLISHED** firm of quality radio manufacturers and component makers requires: Works manager, buyer, sales manager; state age, previous experience and salary required; only those with actual experience in similar capacity need apply; no Civil Servants, temporary or otherwise, need apply.—Box 2327.

**PERMANENT** shore appointments available for skilled radio and radar installation and service engineers; applicants must hold 1st or 2nd class P.M.G. Certificate of Proficiency in Radiotelegraphy; previous sea experience preferable but not essential.—Write, stating qualifications and salary expected to Box 2133. [5924]

**DEVELOPMENT** engineer required to supervise laboratory and development staff; must have thorough knowledge and experience of L.F., H.F., and television technique, with particular emphasis on audio frequency and acoustic work; practical ability to direct and supervise is essential; London area.—Box 2134. [5925]

**INSTRUMENT** makers required N.W. London area; applicants must have considerable previous experience in model making for development of electro-mechanical apparatus and must be capable of working to sketches and instructions in addition to fully detailed drawings; write, giving full particulars of past experience, age, and salary required.—Box 2680. [6159]

**APPLICATIONS** are invited for the position of television engineer capable of creating and taking charge of department; good up-to-date knowledge of design and development and first-class qualifications essential. Experienced mechanical designer also required for radio equipment; good salary to the right men. Factory 30 miles Waterloo.—Please write Box 229. [5942]

**REQUIRE** by large radio firm, S.W. London area, graduate physicist, under 30 years, required to devise and carry out electrical tests as member of a research team working on electrical properties of solids.—Write, with full particulars of qualifications, previous experience, age and salary required, to Box No. 102, L.P.E. 110, St. Martin's Lane, W.C.2, quoting "W.W." [5944]

**RADIO** engineer required to take charge of works laboratory, engaged on check testing all types of radio components and receivers; previous experience in a mass production radio or light electrical factory very desirable; technical qualifications at least equivalent to Grad. I.E.E.; age 35-45 years.—Reply in writing to the Labour Manager, Philips Hamilton Works Limited, Wellhall Rd., Hamilton, Scotland.

**THE MIDDLESEX HOSPITAL, MEDICAL SCHOOL, LONDON, W.1.**—Technician required by department of Physiology for construction and maintenance of electronic apparatus, including high-gain amplifiers and cathode ray oscillographs, used for research and diagnostic purposes, experience in wireless, radar or related branches of physics essential; initial salary £6 p.w.; duties commence October 1st, 1946.—Applications to the Secretary of the Medical School. [5791]

**ELECTRONIC** development engineer required, a good general knowledge and experience of valve circuit design is essential, together with practical ability; particular experience in amplifier design or high-frequency technique will be considered an advantage; qualifications must include a degree in physics or engineering (or satisfactory equivalent); the work offers interesting opportunities in industrial electronic and electro-medical design. Also

**DESIGN** draughtsman required, experience in the design of light electrical apparatus essential, with particular experience in electronic apparatus an advantage; interesting opportunity for suitable man with initiative, good education and practical experience, who will be engaged in design of industrial electronic and electro-medical apparatus; factory is situated in North London.—Write, stating age, qualifications, experience and salary required, to Personnel Manager, The Edison Swan Electric Co., Ltd., Ponders End, Enfield, Middlesex.

**DRUGHTSMAN** required by engineering firm, N.W. London area; applicants must have previous experience in design and development of light electro-mechanical equipment from schematic sketches or specifications and must be able to prepare detailed drawings; previous experience in tele-communication equipment or small electro-mechanical components an advantage, and a knowledge of their electrical application desirable; write, giving full particulars of past experience, age and salary required.—Box 2681. [6160]

**ENGINEERING OPPORTUNITIES**



This unique handbook shows the easy way to secure A.M.I.Mech.E., A.M.Brit.I.R.E., A.M.I.E.E., City and Guilds, etc.

**WE GUARANTEE—'NO PASS—NO FEE.'**

Details are given of over 150 Diploma courses in all branches of Civil, Mech., Elec., Motor, Aero., Radio, Television and Production Engineering, Tracing, Building, Govt. Employment, R.A.F. Maths., Matriculation, etc.

Think of the future and send for your copy at once—FREE.

B.I.E.T., 387, SHAKESPEARE HOUSE, 17, STRATFORD PLACE, LONDON, W.1.



**W. BRYAN SAVAGE LTD.**

Expert assistance in the solution of problems relating to

- TRANSFORMERS, CHOKES
- AMPLIFIERS
- POWER UNITS

and Specialised Equipment embodying

**ELECTRONIC CONTROL**

WESTMORELAND RD., N.W.9  
COLINDALE 7131

**MIDLAND INSTRUMENT CO.**

**WIRELESS REMOTE CONTROL UNITS**, contains a wealth of high-grade items, includes a "T" MK1 buzzer, morse key, key switches, press buttons, conds., chokes, etc., in useful steel cases, weight 10 lbs, cost £12. 25/-, postage 1/-.

**R.A.F. LANDING LIGHTS**, fitted motor, reflector lamp, switchgear, etc. 30/-, carton and postage 2/-.

Both items (brand new) sent for 55/- carriage paid. Hundreds of other lines. Leecos Instrument Wires, etc. New Sept. lists 2/-, with S.A.E. Trade supplied. 18, Harborne Park Rd., Birmingham, 17. Tel. HARborne 1305 or 2664.

**RADIO BATTERY TESTER**

Use "Quixo" method of battery testing.

Reliable results. Guaranteed.

Send for interesting leaflet R115 on battery testing.

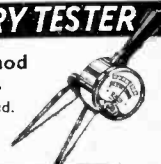

**RUNBAKEN • MANCHESTER**

**TRANSFORMERS & COILS TO SPECIFICATION.**

MANUFACTURED OR REWOUND.

**STANLEY CATTELL LTD**

9-11, East Street, TORQUAY, Devon  
Phone: Torquay 2162.

**REWINDS**

Armatures, Fields, Transformers, Pick-ups, Vacuum Cleaners, Gram. Motors, Speakers Refitted New Cones & Speech Coils.

All Guaranteed and promptly executed Valves, B.V.A. and American, good stocks. Send stamped addressed envelope for list of Radio Spares, and C.O.D. Service.

**A.D.S. Co.** ASTON, BIRMINGHAM, 6



# ARMSTRONG

## Model EXP53

### ALL-WAVE 7-STAGE RADIOGRAM CHASSIS

This new radiogram chassis incorporates wave-band expansion on all bands, e.g., the 16-50-m. band covers just over 20 inches on the large glass scale. Volume and tone controls work on both Radio and Gram. 4½ watts R.C. coupled output. Supplied complete with full size loudspeaker. This chassis has a lively performance, good quality reproduction, and represents excellent value. For 200-250 v. A.C. Mains.

Price, with speaker **£13 plus tax.**

## Model EXP83

### ALL-WAVE 8-VALVE SUPERHET CHASSIS

incorporating wave band expansion. Large glass scale treble boost control. Gram. switching. High quality push-pull output gives 10 watts audio. For 100-250 v. A.C. mains.

Price **14 gns. plus tax.**

## Model EXP43

### ALL-WAVE SUPERHET FEEDER UNIT

incorporating wave band expansion manual I.F. gain control, etc.

Price **11 gns. plus tax.**

## Model EXP63

### ALL-WAVE 6-VALVE SUPERHET CHASSIS

incorporating wave band expansion, Gram. switching. R.C. coupled output. For 100-250 v. A.C. or D.C. mains.

Price **12 gns. plus tax.**

## Model AMP14

**HIGH GRADE AMPLIFIER** in well-finished metal instrument case. Two inputs. Bass compensating circuit, treble boost control, 14 watts push-pull output preceded by 4 triodes.

Price **15 gns.**

Demonstration Sets are now available for interested callers to hear and illustrated technical specifications are now ready.

**ARMSTRONG WIRELESS & TELEVISION CO. LTD**  
WALTERS ROAD, HOLLOWAY, LONDON, N.7  
Phone: NORth 3213

## The HARTLEY-TURNER SPEAKER MODEL 215

is already recognised as a great improvement over the pre-war models. We are deeply grateful for the good wishes sent by so many friends, but have been rather taken aback by the rush of orders. At the moment delivery is about one month. Send for descriptive leaflets of this new and better Speaker and the Service we aim to give you.

Price **£8.5.0** without transformer.

High-grade push-pull O.P. transformer, 55/-.

**H. A. HARTLEY Co. Ltd.**  
132, Hammersmith Rd., London, W.6

**RADIO** engineer required for work on television receivers by an established company; an opportunity for a young man with B.Sc. or equivalent; previous experience on modern pulse technique essential. Write Box D.6018, A.K. Advg. 212a, Shaftesbury Ave. W.C.2. [5956]

**PRODUCTION** manager required by leading electrical manufacturers in South Midlands, for their radio component section; applicants should have sound technical knowledge of this business and experience in the line production of coils, chokes, and transformers.—Apply Box 1983. [5913]

#### SITUATIONS WANTED

**EX-RADAR** mech. (N.C.O. n.R.E.M.E.), 28, single (pre-war radio student), seeks progressive post; London area.—Box 2689. [6143]

**EX-R.A.F.** mechanic, now employed radar engineer, passed Brit.I.R.E. Grad. exam, seeks progressive post anywhere.—Box 1877.

**TECH.** officer R. Sigs., 16 yrs. experience commns. recs., recording, P.A. design and installation, midget design, amateur licence, desires technical post.—Box 1855. [5865]

**SERVICE** engineer of long standing with S manufacturers desires change to outside service, Kent and Surrey; own car; conversant television.—Box 2654, c/o W.W. [6029]

**EX-R.E.M.E.** mech., 5½ years' experience radar, radio, pre-war amateur, good knowledge of television, keen, hard worker, 30 yrs., good refs., requires post.—Box 1859.

**RADIO** service engineer. A.M. Brit. I.R.E. C. and G. Finalist, 16 years' experience radio, sound and communications, inc. 4 years as naval technical officer, seeks suitable position.—Box 2543. [6000]

**EX-Fit. Sergt., R.A.P., radar** mechanic II.Q. fighter Command specialist party, seeks progressive position in experimental or development dept., previous commercial experience; licensed amateur, age 25½.—Apply Box 1985.

**EX-Army** warrant officer, age 32, technical instructor radar 6 yrs, matric., Higher School standard in science, 8 yrs. retail and industrial radio servicing experience, desires progressive and remunerative post.—Box 1880.

**RADIO** engineer (29) seeks post, preferably abroad; apprenticed, C. and G. Final radio communication, 6 years' pre-Army exp., including full time lecturing, 6 years radar, 4½ years commissioned R.E.M.E.—Box 1986.

**CHIEF** radio officer, Merchant Navy, City and Guilds Final, P.M.G. 1st Class, desires shore appointment, anything considered with progressive prospects, experience production tests, retail servicing, 12 years' marine service.—Box 1857. [5862]

**SERVICE** engineer, 34, married, experienced radio and television pre-war and since demob. last Christmas, requires post with responsibility and scope in Home Counties area, change from present employment necessary for domestic reasons.—Box 1891. [5896]

**SGT.** technician (23), R.A.F., desires progressive position with large and progressive concern where ability to develop ideas and produce practical results would be an asset, 2 yrs. civilian experience radio and electrical engineering, 4½ yrs. experience on service radio equipment, gained C. & G.R.S. cert. at 18, received training in draughtsmanship, continuing studies, ultimate aim C. & G. Final and A.M. Brit. I.R.E., residing Midlands.—Box 1890. [5895]

#### AGENCIES

**INDIA.**—Sales executive establishing Calcutta office, arranging 12 months' itinerary, offers manufacturers 1st class representation on all-India basis.—BCM/JAYCO, London, W.C.1.

**HOLLAND.**—Agency, radio, television, accessories. Established Dutch firm, duly introduced with radio dealers throughout the country, is anxious to contact reputable manufacturers of above lines with view to representation in Holland.—Letters No. 1695, Adv. Bur "Recla Technica," Singel 512, Amsterdam-C, Holland. [5963]

#### PATENTS

**THE** proprietor of British patent No. 537177, entitled "Electro-acoustic means for producing sound effects," offers same for licence or otherwise to ensure practical working in Great Britain.—Enquiries to Singer, Ehler, Stern & Carlberg, Stegörs Building, Chicago 4, Illinois, U.S.A. [5809]

**THE** proprietor of British Patent No. 537689, entitled Improvements in wave signalling systems, particularly applicable to facsimile telegraphy, and No. 537699, entitled Improvements in frequency modulation systems, offers same for licence or otherwise to ensure their practical working in Great Britain.—Enquiries to Singer, Ehler, Stern & Carlberg, Chrysler Building, New York City 17, N.Y., U.S.A. [5932]

#### TUITION

**GENTLEMAN** requires competent personal tuition; reasonable fee expected and paid; keen, friendly; London, N.W.—Box 1879.

**J. Bull & Sons, 246, High Street, Harlesden, N.W.10**

I wish to be incorporated in BULL'S mailing scheme, 1946/47.

NAME

ADDRESS

(In block capitals)

**AVO** Minor, Universal, Accurate M/o Meter, 22 Ranges A.C./D.C., Volts, Amps, Ohms, 3" Scale, Leads, Prods, Clips, Booklet, Complete, £8/10/- D.C. Model, £4 4/- E.P.L. Signal Generator, frequency Ranges 100-250, 250-650, 650-1,600 Kcs.; 1.6-4.5, 4.6-12, 12-30 mc/s. Accuracy 1%. Internal Modulation 400 cycles. 6-step Multiplier and Attenuator. A.C. Mains 200-250 v. or 105-115 v. 50/60 cycles. £21/- New 17-Range Universal Multimeter Model by B.P.L., £8/17/6. **ERIE** Resistor Kits of Ceramic Insulated Carbon Resistors. Guaranteed to withstand 100% overload. In metal cabinet with swing lid. 48, 1 watt ranging from 15 Ω to 10 megohms or 96, 1 watt from 12 Ω to 12 megohms. All Colour-coded and marked. 24/- **CAR RADIO.** Canadian Receiver R108. In metal case. Adjustable rod aerial. Spare valves and Vlt. For 6 v. battery. Modern 7-valve Superhet. Self-contained speaker. 19-300 m., £21/- **RAWL-** PUG Workshop Outfit, over 200 parts in handy box; 8 compartments, 24 page book, complete, 15/- **TRANS-RECEIVER** 58. 8-v. A.V.C. 6 mc/s to 9 mc/s. Panel Testmeter. Three Aerials, telescopic. Spare valves. Vtbr. and Fuses, 2 Acc. 2 Mike. 2 pairs Headphones, and Vtbrator Power Unit. All complete. **ELIMINATORS** with Trickle Charger, A.C. 59/6. **B.A. SOCKET** Set in sliding lid box, saves seven sets of Spacers, 6/6. **I.F. Condensers**, 500 v. 8 mfd., 3/2. 8-8 mid., 5/- **Brain MULTICOE** Solder, 13.8 V.W.G., 4/10. **16 V.W.G.**, 5/3. **SERVISOL**, 5/- Trimmer TOOL KITS. Complete outfit for set aligning. 19 assorted screwdrivers and box spanners, with 2 extension handles, in American Cl. Wallet, 30/- **CRYPTON** Ammeter, 0-6 amps., direct wound, 15/- **ROTEX** Ammeter, moving coil, 30 amps. charge, discharge, as fitted to cars, and suitable when external shunt has been removed, for Circuit Testers, Trickle Chargers, etc., 19/6. **Metal ENGRAVING** Pen, electric. From 4-6 v. Battery or A.C. Transformer, 10/- **MICRO-DIAL**, 100-1 with epicyclic reduction, scaled 0-180°, 8/9. **Box** of 12 assorted 1 watt RESISTORS with Colour Code Indicator, 8/- post free. **VARLEY** Thermal Delay Switch, 10/- **VARLEY** Class B Input Transformers, Ratio 2:1, 3:1, 15:1; also 4:1, 3:1, each half 15/- **VARLEY** L.M.F. Input Transf., Ratio 1:4.5, 18/- **VARLEY** L.F. Choke Inductance 5.5 Henries, Res. 50 ohms, max. current 250 ma., 16/- **T.M.C. Electrolytics**, 50 mfd., 12 v., 1/9; 25/25, 1/9; 25/50, 2/6; 50/50, 2/9; 2/150, 2/3; 2/350, 2/3; 8/20, 4/2; 4/450, 3/6; 8/450, 4/- **VOLUME CONTROLS**, all values (no. 1) with switch, 5/3, less switch, 3/- **RADIO CHEMICAL** Equipment: 3 shades Polish, Cement, Servisol, Plastic wood, Chatterton Compound, £1/0/6, post free. "Radio Upkeep and Repairs," a course in itself, most instructive books 9/-, post free. **COMPONENTS:** Full range of tested quality in stock. **BOOKS:** Comprehensive Radio Literature available. **METERS:** Latest Models of Instruments and Test Gear. **SHORTWAVE:** Set of **RAY-MART** Products. **VARLEY:** see September issue of "Wireless World" and note following additions: **APAC**, **DAC32**, **DC784**, **DD18**, **DD101**, **DD260**, **DF33**, **DF34**, **DF39**, **1.550**, **DF96**, **EF9**, **EF12**, **EF36**, **EL5**, **EL50**, **EM34**, **EM38**, **GT10**, **H210**, **HL13**, **KF25**, **KL155**, **KT33C**, **LE3**, **OM0**, **PM12M**, **UB12L**, **UCH4**, **UY1N**. **EXPORT:** Steady Despatch, fully insured. **DEMObILISED** and Forces: Special Attention given. C.O.D. or Remittance with order.

**J. BULL & SONS (W.W.),**  
246, HIGH STREET, HARLESDEN, N.W.10

## L-R-S IN STOCK!

**AVOMINOR TEST METERS**  
A.C./D.C. Universal ..... £8 10 0  
D.C. .... £4 4 0  
Regd. Post 10/-

**CYLDON ELECTRIC DOOR CHIMES**  
Beautifully made. Far more pleasant than buzzer or bell. Front door push operates double chimes, back door only single. Universal model for battery, or mains with bell transformer (extra). Postage 10d. £2 9 6

**STUART Centrifugal Electric PUMPS**  
for machine tool cooling, garden fountains and all pumping purposes. Three sizes. List of Chimes 1d.

ANY OF THE ABOVE SUPPLIED ON EASY TERMS  
**The LONDON RADIO SUPPLY Co.**  
(Est. 1925) **BALCOMBE, SUSSEX**

# MORSE CODE TRAINING



There are Candler Morse Code Courses for **BEGINNERS AND OPERATORS.**

Send for this Free 'BOOK OF FACTS'

It gives full details concerning all Courses.

**THE CANDLER SYSTEM CO.,** (Room 55W), 121 Kingsway, London, W.C.2  
Candler System Co., Denver, Colorado, U.S.A.

**A** NEW course now available deals with practical radio servicing and introduces new and hitherto unpublished methods; unsuitable for beginners; send for free details to: BCM/CIRCUIT, London, W.C.1. [5735  
**BUSINESSES FOR SALE**  
**C**ORRESPONDENCE School, well established, privately owned with laboratory for practical tuition, technical subjects: ripe for expansion. Particulars to Solicitors for prospective purchasers only.—Apply Barton & Pearman, 25, Palace St., London, S.W.1.

# Beethoven RADIO

**BEETHOVEN ELECTRIC EQUIPMENT LTD.**  
BEETHOVEN WORKS, CHASE RD., LONDON N.W.10

# MATRICULATION

*brings Success & Security*

Whatever your age, you can now study for the all-important Matriculation Examination at home on "NO PASS—NO FEE" terms. "MATRIC" is the accepted passport to all careers, and opens up opportunities which would otherwise be completely closed to you. Ensure the success and security of you and yours through post war difficulties by writing for our valuable "Guide to Matriculation" immediately—**FREE**

**B.T.I. (Dept. 114)**  
356, Oxford Street, London, W.1.

## ERG'S HAVE THE URGE TO GO ABROAD

**SPEAKING EXPORTLY...**

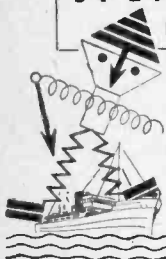

**ERG Resistors** have an exceptional electrical specification and performance, with mechanical strength. High-grade Vitreous Enamels used on our Tropical Resistors give long life, and definitely assist in the trouble-free manufacture and performance of Radio Receivers, Television and Test Equipment. **ERG Resistors** are processed up to the highest Service Standards at a competitive Price.



**ERG INDUSTRIAL CORPORATION LTD.**  
SALES OFFICE: 10 PORTMAN SQUARE, LONDON, W.1  
TELE.: WELBECK 3892

## BRITISH PHYSICAL LABORATORIES

### 17 RANGE UNIVERSAL TEST SET

1,000 ohms per volt on A.C. and D.C. ranges. Toughened glass. Size 5 1/4" x 4 1/8" x 2 3/4". Ranges A.C. and D.C. volts 0/10, 0/50, 0/100, 0/500, 0/1,000, 0/1 megohm (External battery). D.C. milliamps 0/1, 0/10, 0/100, 0/500. Resistance Ranges 0/1,000 and 0/100,000 ohms. Accuracy 2%. Rotary Range Selector. Price **£8 17s. 6d.**

If unable to obtain this high grade instrument from your dealer, apply to U.K. Trade Distributors:—**RADIO AGENCIES LIMITED,** 157, WARDOUR STREET, W.1. Phone: GERRARD 4458

Even 24 hours' immersion in seawater cannot affect impervious

## Welwyn Resistors



Tested independently, a standard Welwyn Vitreous Resistor worked perfectly after 24 hours' immersion in seawater. Sizes—1 w. to 300 w. Also High Stability Carbon Resistors—1/4 w. to 2 w.

New Trade catalogue available  
**WELWYN ELECTRICAL LABS. LTD**  
Welwyn Garden City, Herts.  
Phone: WEL GAR. 3816-8

# Remember-Walter

RADIO STAMPINGS • RADIO CHASSIS • RADIO PRESSINGS  
FARM LANE, FULHAM, S.W.6 TELEPHONE: FULHAM 5234

Use **Varley** TRADE MARK  
PUSH PULL TRANSFORMERS  
L.F. CHOKES  
THERMAL DELAY SWITCHES  
POWER POTENTIOMETERS

to obtain high fidelity reproduction from your **AMPLIFIER**

**OLIVER PELL CONTROL LTD**  
CAMBRIDGE ROW • WOOLWICH • S.E.18  
TELEPHONE: WOOLWICH • 42276



## Moving-Coil Microphones

BRIT. PAT. No. 556137

Write for full descriptive leaflet to Dept. W.W.9

**LUSTRAPHONE LTD.,** 84, BELSIZE LANE, LONDON, N.W.3.  
Telephone: HAMPSTEAD 5389 and 5515.

For extreme sensitivity and selectiveness, these Microphones cannot be excelled. From the specially suspended and protected diaphragm to the sturdy all-weather case housing the delicate movement, everything has been designed to give complete faithfulness of response. To demand the most critical standards is to demand LUSTRAPHONE, the Master Microphone.

# TCC CONDENSERS

## Improved Deliveries!

Only the short-sighted manufacturer gets any satisfaction from sitting back and saying "Our delivery is blankety blank weeks!" We certainly don't feel that way at T.C.C. where, in more normal times, most things were available from stock and deliveries commenced—even of elaborate special types—in 14 days or so. We are not back to that position yet (nor are our suppliers) but there is a

glimmer of light here and there. The "tightest" item is ELECTROLYTICS but production is increasing each week and large allocations are going out to all sections of the trade. MICA condensers are in a good position and most sizes can now be supplied Ex Stock. PAPER CONDENSERS too are doing nicely thanks! as is shown by the following tables of lines available FROM STOCK

**Tropicalised PAPER BLOCK CONDENSERS**  
(Hermetically sealed in Metal Containers and fitted with moulded terminals.)

Capacity Mfds.	Wkg. Voltage D.C.	Type No.	List Price each.	Capacity Mfds.	Wkg. Voltage D.C.	Type No.	List Price each.
0.1	350	62	4/-	0.5	750	92	5/6
0.25	350	62	4/6	1.0	750	92	6/6
0.5	350	62	4/9	2.0	750	92	11/-
1.0	350	62	5/6	0.25	1,000	111	5/9
2.0	350	62	6/9	0.5	1,500	121 B	6/9
0.1	500	82	4/3	0.05	1,500	121 B	5/3
0.25	500	82	4/9	0.1	1,500	121 B	6/-
1.0	500	82	6/-	0.25	2,000	131	7/-
2.0	500	82	7/6	0.1	2,000	131	8/9
4.0	500	82	13/-	1.0	2,000	131	13/6
8.0	500	82	22/-	0.5	4,000	171 A	30/-
10.0	500	82	27/-				



**Tropicalised PAPER TUBULAR CONDENSERS**  
(Hermetically sealed in Metal Tubes with end wire connections.)

Capacity Mfds.	Wkg. Voltage D.C.	Type No.	List Price each.	Capacity Mfds.	Wkg. Voltage D.C.	Type No.	List Price each.
0.1	350	CP.45.N	2/1	0.25	500	CP.47.S	2/10
0.25	350	CP.48.N	2/8	0.5	500	CP.90.S	3/10
0.5	350	CP.47.N	3/-	0.05	750	CP.45.U	1/10
1.0	350	CP.91.N	4/-	0.02	1,000	CP.45.W	1/10
0.05	500	CP.45.S	2/1	0.01	1,000	CP.45.W	1/10
0.1	500	CP.46.S	2/2	0.1	1,000	CP.47.W	2/6

**TELEVISION REPLACEMENTS**

We are giving priority to condensers required for the above purpose. Quick delivery can be given of the T.C.C. "CATHODRAY" Condenser—0.1 Mfd., 6,000 v., D.C. working. List price 15/-

Please order through your usual factors, but in case of difficulty, communicate with us direct.

**Remember** these are new components direct from the source of manufacture; they are fully guaranteed—with none of the "ifs and buts" of surplus "bargains."

## THE TELEGRAPH CONDENSER CO. LTD.

RADIO DIVISION

NORTH ACTON · LONDON · W.3

TELEPHONE: ACORN 0061



A cylindrical radio valve with a glass envelope and metal base, shown against a background of white wavy lines. The label on the valve reads 'MAZDA VALVE VP.41'.

VP. 41	
Filament Voltage	4.0V
Filament Current	0.65A
Maximum Anode Voltage	250V
Maximum Screen Voltage	250V
Mutual Conductance	3.0mA/V



A cylindrical radio valve with a glass envelope and metal base, shown against a background of white wavy lines. The label on the valve reads 'MAZDA VALVE VP.133'.

VP. 133	
Filament Voltage	13.0V
Filament Current	0.2A
Maximum Anode Voltage	200V
Maximum Screen Voltage	200V
Mutual Conductance	3.1mA/V

The VP. 41, designed for use in A.C. Mains Receivers and the VP.133, in AC/DC Receivers, are Variable-mu Screened Pentodes.

Both valves are particularly suitable for use in the I.F. and H.F. stages of All-Wave Receivers when a variable-mu characteristic is required. Their signal handling capacity is very large and cross modulation has been reduced to a low value.

In receivers where it is desired to reduce components to a minimum it is possible to feed the screen voltage to these valves and their respective frequency changers, TH.41 and TH.233, through a common series resistance.

In relation to anode voltages the maximum rated screen voltages are remarkably high for this class of valve.

# MAZDA

## RADIO VALVES AND CATHODE RAY TUBES

THE EDISON SWAN ELECTRIC CO. LTD., 155, CHARING CROSS ROAD, LONDON, W.C.2

R.M.43.